

The Hygiene Cleaning System



11 Colours available

Das Hygiene Reinigungssystem - Innengewinde
Det Hygiejniske Rengøringssystem - Indvendig gevind
Le système de nettoyage hygiénique - Douille interne

Inside thread



Campden BRI
food and drink innovation

We have been manufacturing quality cleaning products since 1887



Where our products perform:

Anywhere and everywhere that uncompromising cleanliness is the overarching requirement. Typical market types that appreciate our products include: food and beverage processing, food handlers, service sector and retail outlets, pharmaceutical and medical manufacturers, hospitals, municipal cleaning, contract cleaners etc.

Declaration of Compliance

Our range of hygiene brushes fulfill all requirements for the BRC Global and IFS standards. For all articles meant for direct food contact the Declaration of Compliance (DoC) can be downloaded at www.fbk.dk

Unser Produktprogramm an Hygienebürsten erfüllt alle Anforderungen des BRC Global sowie des IFS-Standards. Für alle Produkte, die für den direkten Kontakt mit Lebensmitteln geeignet sind, können Sie Konformitätserklärungen (DoC) unter www.fbk.dk downloaden.

Vores sortiment af Hygiene produkter opfylder standarderne BRC Global og IFS. Declaration of Compliance (DoC) kan downloades på www.fbk.dk under hvert produkt hvor det er et krav.

Notre gamme de Brosserie Alimentaire répond aux exigences du référentiel d'audit International Featured Standards (IFS) et à la norme du British Retail Consortium (BRC). Une déclaration de Conformité pour tous les articles destinés au contact alimentaire est téléchargeable sur www.fbk.dk



FBK ist ein dänisches Unternehmen, das seit 1887 Qualitätsprodukte für die Reinigungsindustrie herstellt

Wo unsere Produkte eingesetzt werden

Typische Bereiche die mit unseren Produkten arbeiten sind: Nahrungs- und Getränkeindustrie, Lebensmittelindustrie, Pharma - und Medizintechnik, Dienstleistungsunternehmen, Krankenhäuser, Gebäudereiniger, Einzelhandel, Stadtreinigungen etc. Die beste Sauberkeit zu erreichen ist für FBK oberste Priorität.

FBK - en dansk virksomhed som har fremstillet kvalitetsprodukter til rengørings- og levnedsmiddelindustrien siden 1887

Hvor kan man bruge vores produkter?

Sortimentet er specielt designet til områder hvor der kræves en høj og effektiv kvalitet af rengøringen og hvor hygiejnen er essentiel, f.eks.: levnedsmiddel-, farmaceutindustrien, bryggeribranchen, hospitaler, landbrug, supermarkeder, fødevarerforhandler og lign.

FBK est une société danoise qui fabrique des produits de nettoyage de qualité depuis 1887.

Domaines D'utilisation

Partout où il s'agit d'abord de garantir la meilleure propreté. On retrouve nos produits dans l'agro-alimentaire, la production de boissons, la distribution des produits alimentaires, l'industrie pharmaceutique, la fabrication de produits médicaux, les hôpitaux, les municipalités, les sociétés de nettoyage, etc.



Colour code

Farbcode | Farvekode | Code couleur

When ordering please add colour code after the art. number:
(eg. 10548-2 = churn brush -> blue)

Bei Bestellungen bitte die Farbcode-Nummer hinter die letzte Stelle der Artikelnummer setzen: 10548-2 = Stielbürsten -> Blau

Ved bestilling, venligst anfør farvekoden efter varenr.:
(F.eks. 10548-2 = Spande børste -> blå)

À la commande, ajouter le code couleur à la référence:
(p. ex. 10548-2 = brosse à man-che de couleur bleue)

1	XXXXX-1 = White Weiß Hvid Blanc
2	XXXXX-2 = Blue Blau Blå Bleu
3	XXXXX-3 = Red Rot Rød Rouge
4	XXXXX-4 = Yellow Gelb Gul Jaune
5	XXXXX-5 = Green Grün Grøn Vert
6	XXXXX-6 = Black Schwarz Sort Noir
7	XXXXX-7 = Orange Orange Orange Orange
8	XXXXX-8 = Purple Violett Lilla Violet
9	XXXXX-9 = Pink Pink Pink Rose
11	XXXXX-11 = Grey Grau Grå Gris
12	XXXXX-12 = Brown Braun Brun Marron



Features

Produkteigenschaften | Egenskaber | Caractéristiques



Very soft | Sehr weich
Meget blød | Très souple



Soft | Weich
Blød | Souple



Medium | Mittel
Medium | Moyen



Stiff | Hart
Stiv | Raide



Very stiff | Sehr hart
Meget stiv | Très raide



Flagged material | Geschlitzte Borsten
Spaltet filamenter | Fibre fleurée



Waterfed | Wasserdurchlauf
Vandgennemløb | Passage d'eau



Adjustable angle | Drehgelenke
Drejeled | Angle réglable



Pack size | Packungsgröße
Stk. pr. karton | Conditionnement



Heat tolerance | Hitzebeständigkeit
Varmebestandighed | Résistance à la chaleur



Trimsizes | Besatshöhe
Børstelængde | Tirure



PHB approved | PHB genehmigt
PHB godkendt | Approuvé PHB

The hygiene range

Brushes and handles

Bürsten und Stiele
Børster og skafter
Balais et Manches

4 - 19

Hand brushes and hygiene tools

Handbürsten und Reinigungssysteme
Håndbørster og hygieneredskaber
Balayettes et Outils Alimentaires

20 - 35

Detectable range

Detektierbare Produkte
Detekterbar
Détection des Métaux

36 - 41

METAL + X-RAY
DETECTABLE + DETECTABLE

Resin-Set

Resin-Set
Resin-Set
Ensemble en résine

42 - 44



Waterfeed

Wasserdurchlauf
Vandgennemløb
Ecoulement de l'eau

45 - 50



General product information

Allgemeine Produktinformation
Generel produktinformation
Informations générales

53 - 55

Brushes and handles

Deck scrubs

Schrubber | Gulvskrubber | Balai Brosse

20153-	280 x 50 mm	Polyester PBT 0.50	130		1	2	3	4	5			11	12		
21153-	400 x 50 mm	Polyester PBT 0.50	130		1	2	3	4	5	6		8			
22153-	225 x 60 mm	Polyester PBT 0.50	130		1	2	3								
23153-	300 x 60 mm	Polyester PBT 0.50	125		1	2	3	4	5	6	7	8	9	11	12



Deck scrub w/side filaments

Schrubber halvbrund | Gulvskrubbe m/ sidebørster | Balai Brosse avec fibres aux extrémités

20154-	285 x 120 mm	Polyester PBT 0.50	125/40		1	2	3	4	5				
--------	--------------	--------------------	--------	--	---	---	---	---	---	--	--	--	--

Multi deck scrub "high/low"

Allzweckwascher | Multi gulvskrubber "høj/lav" | Balai brosse semelle courbe

20155-	285 x 130 mm	Polyester PBT 0.50	145		1	2	3	4	5	6	7	8	9
--------	--------------	--------------------	-----	--	---	---	---	---	---	---	---	---	---



20155

Extremely flexible deck scrub, due to the shape it works perfect below machines, in corners, on walls, on floors etc.

Sehr flexibler Allzweckwascher, besonders geeignet für Maschinen, in Ecken, auf Fluren etc.

Ekstrem fleksibel gulvskrubbe, formen gør rengøringen mere effektiv under f.eks. maskiner, i hjørner, på vægge og på gulve.

Balai brosse très flexible, grace à sa forme il permet de passer aisément sous les machines, dans les coins, sur les murs, etc.

Brushes and handles

Sweepers

Besen | Fejekoste | Balais Droit

20136-	280 x 50 mm	Polyester PBT 0.30	1\$55		1	
21136-	400 x 50 mm	Polyester PBT 0.30	1\$55		1	
26135-	500 x 60 mm	Polyester PBT 0.30	1\$55		1	
27136-	600 x 60 mm	Polyester PBT 0.30	1\$55		1	



Sweepers, flagged

Besen, geschlitzt | Fejekoste, spaltet børster | Balais droit fibres fleurées

20106-	280 x 50 mm	Polyester PBT 0.30	1\$55		1	
21106-	400 x 50 mm	Polyester PBT 0.30	1\$55		1	
27106-	600 x 60 mm	Polyester PBT 0.30	1\$55		1	

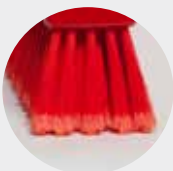

20106 + 21106 + 27106

Flagged material; means that the tip of the filaments have been flagged into 20-30 smaller filaments, good when you need to carry water, soap etc. bad in the bake industry.

Geschlitzte Borsten bedeutet, dass die Borsten am Ende 20-30 mal feiner aufgetrennt werden. Diese Besen eignen sich sehr gut, wenn mit Wasser, Reinigungsmitteln etc. gearbeitet wird. Nicht geeignet sind diese Besen in der Backindustrie.

Spaltet børster = enden af filamentet er spaltet i 20-30 mindre filamenter. God til at holde på f.eks. vand og sæbe, men kan ikke anbefales i f.eks. bagerindustrien.

Fibre fleurée signifie que l'extrémité des fibres a été séparée en 20-30 plus petits filaments, afin de mieux attraper l'eau, le savon, etc. déconseillée pour l'usage en boulangerie.

Brushes and handles

Spanish style sweepers

Besen mit gerader Stielaufnahme (Spanish Style) | Fejekoste (spansk design) | Balais droit (lavage espagnol)

24147-	280 x 48 mm	Polyester PBT 0.30	170		1	2	3	4	5	6	7	8	9	11	12
24157-	280 x 48 mm	Polyester PBT 0.50	170		1	2	3	4	5	6	7	8		11	12
25147-	400 x 50 mm	Polyester PBT 0.30	170		1	2	3	4	5		7				
25157-	400 x 50 mm	Polyester PBT 0.50	170		1	2	3	4	5		7				



Narrow sweepers (spanish style)

Besen schmal (Spanish Style) | Smal fejekost (spansk design) | Balais droit, fin et étroit (lavage espagnol)

20157-	260 x 35 mm	Polyester PBT 0.50	180		1	2	3	4	5						
--------	-------------	--------------------	-----	--	---	---	---	---	---	--	--	--	--	--	--

Narrow sweeper with angle cut (spanish style)

Besen schmal mit schrägem Besatzschnitt (Spanish Style) | Smal fejekost med vinkel cut (spansk design) | Balais droit, semelle courbe (lavage espagnol)

20195-	300 x 35 mm	Polyester PBT 1.00	120-170		1	2	3	4	5	6	7	8	11	12
--------	-------------	--------------------	---------	--	---	---	---	---	---	---	---	---	----	----



24147 + 24157 + 25147 + 25157

"Spanish style" are brushes with up-right thread. Bei "Spanish Style" handelt es sich um Besen mit gerader Stielaufnahme. Spansk design er børster med vinkelrettet gevind. Le "lavage espagnol" fait référence aux balais avec douille de serrage verticale.



20195

Narrow sweeper with filament cut with an angle. Especially good for lobby pan - see page 32. Besen schmal mit abgeschragten Borsten (Schragschnitt). Besonders gut für den Kehrbehälter geeignet (siehe Seite 32). Small fejekost med børstehår skåret i vinkel. Speciel god til Lobby pan. Se side 32. Ce "Balai fin et droit" possède un filetage coupé en biais. Idéal pour Pelle aéroport - voir page 32.

Brushes and handles

Sweeper, soft and tight

Besen, weich und dicht | Fejekost, blød og fyldig | Balai droit, fin et étroit

21126-	400 x 50 mm	Polyester PBT 0.20	1	50		1	2	3	4	5	7	8
--------	-------------	--------------------	---	----	--	---	---	---	---	---	---	---

Combination sweepers

Kombibesen, borsten-mix | Kombinationsfejekoste | Balai combiné

21176-	400 x 50 mm	Polyester PBT 0.30/0.70=	6	55		1	2	3	4	5	6	7	8	11	12
27176-	600 x 60 mm	Polyester PBT 0.30/0.70=	6	55		1	2	3	4	5	6	7			



Brooms, medium

Besen, mittel | Fejekoste, medium | Balai medium

23155-	300 x 60 mm	Polyester PBT 0.50	1	55		1	2	3	4	5	6					
25155-	400 x 60 mm	Polyester PBT 0.50	1	55		1	2	3	4	5	6	7	8	9	11	12
26155-	500 x 60 mm	Polyester PBT 0.50	1	55		1	2	3	4	5						
27156-	600 x 60 mm	Polyester PBT 0.50	1	55		1	2	3	4	5	6	7	8			



21126

Very soft and tight | ~20% more filled, made for fine dust.

Sehr weich und dichtbestückt | ~20% mehr Besatzdichte, besonders geeignet für feinen Staub.

Ekstra blød og tæt ~20% flere filamenter. God til meget fin støv, f.eks. bagerindustrien.

Très doux et fin / 20% plus fourni, spécial pour la poussière fine.



21176 + 27176

Black stiff front filaments loosen stubborn debris allowing soft rear filaments to sweep and collect effectively.

Die schwarzen harten Borsten lösen den Schmutz und mit den weichen Borsten kehren Sie den Schmutz effektiv zusammen.

Forrest, sorte stive front filamenter til fastsiddende snavs. Bagerst, bløde filamenter til at feje og samle effektivt.

Les fibres noires à l'avant détachent les débris persistant permettant aux fibres douces de balayer et ramasser efficacement.

Brushes and handles

Brooms, stiff

Straßenbesen | Gulvkoste | Balai PBT fibre rigide

23187-	300 x 60 mm	Polyester PBT 1.00	‡65		1	2 3 4 5
25187-	400 x 60 mm	Polyester PBT 1.00	‡65		1	2 3 4 5 6 8



High brooms, stiff

Straßenbesen mit langem Schnitt | Høje gulvkoste | Balais PBT fibre très rigide

23190-	300 x 60 mm	Polyester PBT 1.00	‡110		1	2 3
25190-	400 x 60 mm	Polyester PBT 1.00	‡110		1	2 3 4 5 6 7 8 11 12
26190-	500 x 60 mm	Polyester PBT 1.00	‡110		1	2 3 4 5



23190 + 25190 + 26190

Tall broom on 110 mm with very stiff filaments. Perfect for outdoor use or harsh cleaning.
 Strassenbesen mit langen, extra harten Borsten. Ideal für den Außeneinsatz und rauhen Untergrund.
 Høj gulvkost på 110 mm med stive filamenter. Perfekt til udendørs brug og hård rengøring.
 Balai avec semelle de 110mm et fibres très raides. Parfait pour un usage extérieur ou un lavage difficile.

Brushes and handles

Sweepers with Polypropylene PPN, flagged

Besen mit PPN-Borsten | Fejekoste med polypropylen | Balai en Polypropylène

20306-	280 x 50 mm	Polypropylene 0.25 Polypropylen PPN Polypropylene Polypropylène	‡55		1	2	3	4	5
21306-	400 x 50 mm	Polypropylene 0.25 Polypropylen PPN Polypropylene Polypropylène	‡55		1	2	3	4	5
26306-	500 x 60 mm	Polypropylene 0.25 Polypropylen PPN Polypropylene Polypropylène	‡55			2			



Sweeper with Polypropylene PPN

Besen mit PPN-Borsten | Fejekoste med polypropylen | Balai en Polypropylène

21336-	400 x 50 mm	Polypropylene 0.25 Polypropylen PPN Polypropylene Polypropylène	‡55		1	2	3
--------	-------------	-----------------------------------------------------------------------	-----	--	---	-------------------------------------------------------------------------------	-------------------------------------------------------------------------------



Polypropylene

This filament has good abrasion resistance and excellent chemical resistance to both acids and alkali solutions. It has an inferior bend recovery to Polyester.

Diese Borste besitzt eine hohe Abriebfestigkeit und ausgezeichnete chemische Resistenz gegenüber sauren und alkalischen Lösungen. Im Vergleich zu Polyester verfügt sie über eine geringere Rückstellfähigkeit.

Filamenter af polypropylene er slidtærke og har fremragende kemiske resistente egenskaber over for både syre og base løsninger. Sammenlignet med polyester er elasticiteten lavere.

« Cette fibre possède une excellente résistance aux frottements et substances chimiques, tant aux acides qu'aux solutions alcalines. Reprend sa forme plus lentement que le Polyester après pliage. »

For General information
See page 53



Brushes and handles

Tube cleaning brushes for handle

Rohrbürsten | Rørrensere | Brosses à tuyaux

27121-	ø 63 x 95 x 120 mm	Polyester PBT 0.20	‡9		1	2	3	4	5	6
27131-	ø 70 x 95 x 120 mm	Polyester PBT 0.30	‡12		1	2	3	4	5	6
27132-	ø 80 x 100 x 125 mm	Polyester PBT 0.30	‡18		1	2	3	4	5	6
27133-	ø 90 x 105 x 130 mm	Polyester PBT 0.30	‡23		1	2	3	4	5	6
27152-	ø 105 x 115 x 140 mm	Polyester PBT 0.50	‡30		1	2	3	4	5	6
27153-	ø 120 x 120 x 145 mm	Polyester PBT 0.50	‡38		1	2	3	4	5	6



Tank brushes

Tankschrubber | Tankbørster | Brosses forme tête de loup

27104-	220 x 140 mm	Polyester PBT 0.30	‡40		1	2											
27134-	200 x 120 mm	Polyester PBT 0.30	‡35		1	2	3	4	5	6	7	8	9	11	12		
27154-	200 x 120 mm	Polyester PBT 0.50	‡35		1	2	3	4	5	6	7	8	9	11	12		



27104



27134



27154

i



27104 + 27134 + 27154

Designed for cleaning of containers and other objects with hard edges and corners.

Entwickelt zur Reinigung von Behältern insbesondere deren Ecken und Kanten.

Designet til rengøring af tanke, beholdere og andre genstande med svære kanter og hjørner.

Conçu pour le nettoyage de conteneur et d'autres objets aux bords et coins rigides.



Brushes and handles

Tube cleaning brushes, outside cleaning, for handle

Reinigungsbürsten | Børste til udvendig rengøring af rør | Brosses pour nettoyage de l'extérieur des tubes

27250-2 ø 50 x 300 x 580 mm Polyester PBT 0.30

27260- ø 100 x 340 x 600 mm Polyester PBT 0.30



2

2 3 4 5

Slut drain brush

Abflussreiniger | Afløbsrensere | Brosse pour évacuations

27255- ø 60 x 150 x 390 mm Polyester PBT 0.50



6

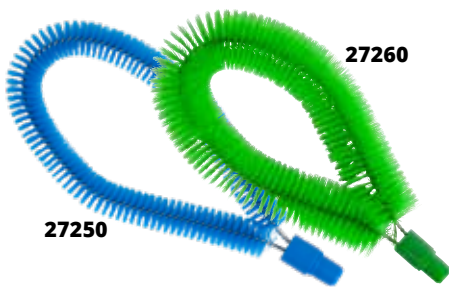

27250 + 27260
 Flexible brushes - shape it as you wish.
 Flexible Bürsten - formbar nach Anwendungszweck.
 Fleksible, kan bøjes til ønsket form.
 Brosse flexible, vous pouvez lui donner la forme que vous voulez

Pad holder & pads

Padhalter und Pads | Skurenylonholder og skurenylon | Semelles et abrasifs

27101- 230 x 100 mm

15123 250 x 120 mm Floor pad | Pad | Pad | Abrasif pour sol Nylon Poliester

15121 250 x 120 mm Floor pad | Pad | Pad | Abrasif pour sol Nylon Poliester

15122 250 x 120 mm Floor pad | Pad | Pad | Abrasif pour sol Nylon

15124 250 x 120 mm Floor pad | Pad | Pad | Abrasif pour sol Nylon

15125 250 x 120 mm Floor pad | Pad | Pad | Abrasif pour sol Nylon

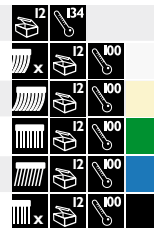

1

2 3 4 5 6 7

11 12



27101

Unique design provides firm grip for positive action at any angle.

Das neue Design bietet eine festere Verbindung zwischen Padhalter und Pads. Außerdem ermöglicht es eine gründliche Reinigung auch in schwer zugänglichen Ecken.

Unik design som fastholder skurenylon, fleksibelt drejeled.

Le système d'accroche à la semelle permet de fixer fermement la lingette pour un nettoyage optimum des angles.





Squeegees for professional use!



Brushes and handles

Condensation squeegee

Dedicated for condensation, not a compromise!



A one-piece super hygienic condensation squeegee:

- Hygienic design
- 'Food approved' raw material
- Very easy to clean, no 'hidden' corners
- 420 mm
- Curved design, to fit both plain and curved surfaces, tubes etc.
- Flexible rubber lip



0427



0429

29828

Kondenswasserabzieher:

- Hygienisches Design
- Hochwertige für den Lebensmittelkontakt zugelassene Rohstoffe
- Sehr leicht & einfach zu reinigen
- 420 mm
- Durch die leicht geschwungene Form, passt sich der Kondenswasserschieber glatten und unebenen Oberflächen an
- Flexible Gummilippe

Kondensskraber:

- Hygiejnisk design
- Fødevarer godkendt
- Let at rengøre, ingen skjulte hjørner
- 420 mm
- Designet til både flade og kurvede overflader
- Fleksibelt gummi

Racleau une épaisseur:

- Conception hygiénique
- Matière première respectant les aliments
- Facilité de nettoyage, aucun coins oubliés
- 420 mm
- Design incurvé, qui s'adapte aux surfaces plates, incurvés, tubes etc
- Caoutchouc souple.



Condensation squeegee, bottle, hose and telescopic handle with 1/2" nippel

Kondenswasserabzieher, sammelflasche, Schlauchen und Teleskopstiele mit 1/2"-Anschluss

Kondensskraber, flaske, slange og teleskop skaft til kondensskraber | Racleau une épaisseur: racle l'eau sur surface lisse jusqu'à condensation, oite de condensation, manche et tuyau télescopiques avec embout 1/2"

28420-	420 mm	One-piece super hygienic Einteilig, sehr hygienisch Fuldstøbt, super hygienisk Racleau une épaisseur très hygiénique		1	
29775-N	1600 → 5300 x 34 mm	1/2" nippel 1/2" Anschluß 1/2" nippel Embout 1/2"			See images at page 19
29779-N	1900 → 9500 x 46 mm	1/2" nippel 1/2" Anschluß 1/2" nippel Embout 1/2"			See images at page 19
29828-	1250 → 2000 x 32 mm	1/2" nippel 1/2" Anschluß 1/2" nippel 1/2" Cople		1	
29826-	1750 → 3000 x 32 mm	1/2" nippel 1/2" Anschluß 1/2" nippel 1/2" Cople		1	
0427	1/2", 1 liter	Polyethylene PE Polyethylen PE Polyethylene PE Polyéthylène (PE)			
0429	1/2", 1500 mm	PVC			

Brushes and handles

One-piece squeegees super hygienic

Wasserschieber einteilig | Fuldstøbte gulvskræbere | Racleau une épaisseur très hygiénique

28300-	300 mm	Full coloured Vollfarbig Fuldstøbt Mono couleur		1	2	3	4	5	6	7	8			
28400-	400 mm	Full coloured Vollfarbig Fuldstøbt Mono couleur		1	2	3	4	5	6	7	8	9	11	12
28500-	500 mm	Full coloured Vollfarbig Fuldstøbt Mono couleur		1	2	3	4	5		7	8			
28600-	600 mm	Full coloured Vollfarbig Fuldstøbt Mono couleur		1	2	3	4	5	6	7	8	9	11	12
28700-	700 mm	Full coloured Vollfarbig Fuldstøbt Mono couleur		1	2	3	4	5		7	8			

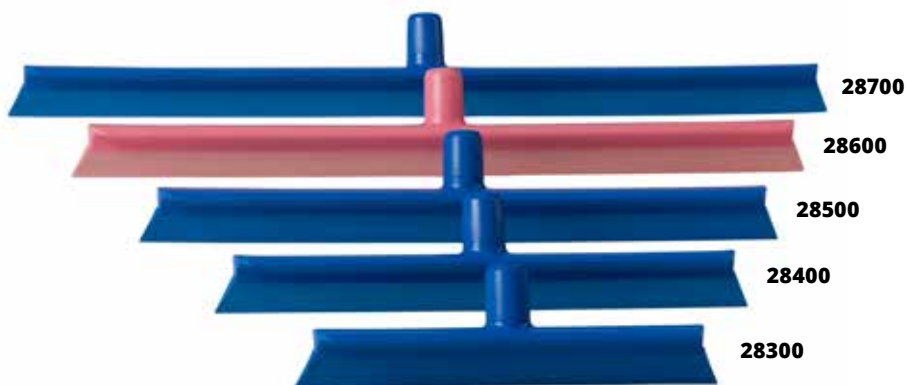

Squeegees with white rubber

Wasserschieber mit weißem Gummi | Gulvskræbere med hvid gummi | Raclette sol, avec mousse blanche

28403-	400 mm	White rubber Weißer Gummi Hvid gummi Avec mousse blanche		1	2	3	4	5	6	7	8			
28503-	500 mm	White rubber Weißer Gummi Hvid gummi Avec mousse blanche		1	2	3	4	5	6	7	8			
28603-	600 mm	White rubber Weißer Gummi Hvid gummi Avec mousse blanche		1	2	3	4	5	6	7	8			
28703-	700 mm	White rubber Weißer Gummi Hvid gummi Avec mousse blanche		1	2	3	4	5	6	7	8			



27200

Angle connector

Winkeladapter | Vinkeladapter | Embout Flexible

27200-		1	2	3	4	5	6	7	8
--------	--	---	---	---	---	---	---	---	---

A tool for more flexible cleaning | Ein Arbeitsmittel für erhöhte Reinigungsflexibilität
For fleksibel rengøring | Un outil pour un nettoyage plus flexible



One-Piece Squeegees

Extremely effective action when both pushing or pulling. Moves water effortlessly from smooth surfaces, along with condensation.

Wasser bzw. Flüssigkeiten werden durch Schieben oder Ziehen des Wasserschiebers von glatten Oberflächen gründlich entfernt.

Meget effektivt og hygiejnisk gulvskræber. Fjerner effektivt vand og kondens.

Permet de pousser ou de tirer efficacement. Racle l'eau sans effort des surfaces lisses jusqu'à condensation.



Brushes and handles

Squeegees with black rubber

Wasserschieber mit schwarzem Gummi | Gulvskrabere med sort gummi | Raclette sol, avec mousse noire

28406-	400 mm	Black rubber Schwarzer Gummi Sort gummi Avec mousse noire		1	
28506-	500 mm	Black rubber Schwarzer Gummi Sort gummi Avec mousse noire		1	
28606-	600 mm	Black rubber Schwarzer Gummi Sort gummi Avec mousse noire		1	
28706-	700 mm	Black rubber Schwarzer Gummi Sort gummi Avec mousse noire		1	



Squeegees with pivot and white rubber

Wasserschieber mit Drehgelenk und weißem Gummi | Gulvskrabere med drejeled og hvid gummi
Raclette sol, avec mousse blanche

28453-	400 mm	White rubber Weißer Gummi Hvid gummi Avec mousse blanche		1	
28553-	500 mm	White rubber Weißer Gummi Hvid gummi Avec mousse blanche		1	
28653-	600 mm	White rubber Weißer Gummi Hvid gummi Avec mousse blanche		1	

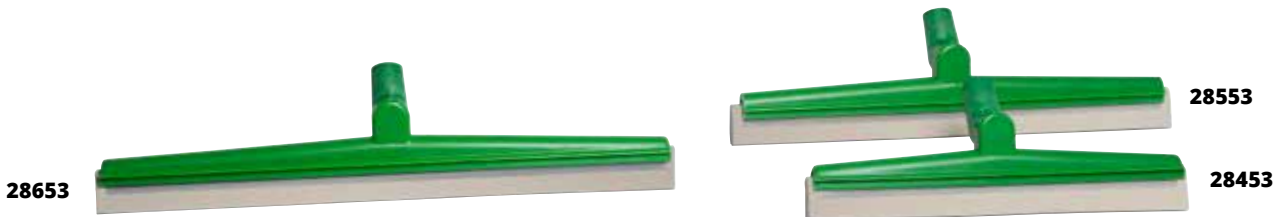

Squeegees with pivot and black rubber

Wasserschieber mit Drehgelenk und schwarzem Gummi | Gulvskrabere med drejeled og sort gummi
Raclette sol, avec mousse noire

28456-	400 mm	Black rubber Schwarzer Gummi Sort gummi Avec mousse noire		1	
28556-	500 mm	Black rubber Schwarzer Gummi Sort gummi Avec mousse noire		1	
28656-	600 mm	Black rubber Schwarzer Gummi Sort gummi Avec mousse noire		1	

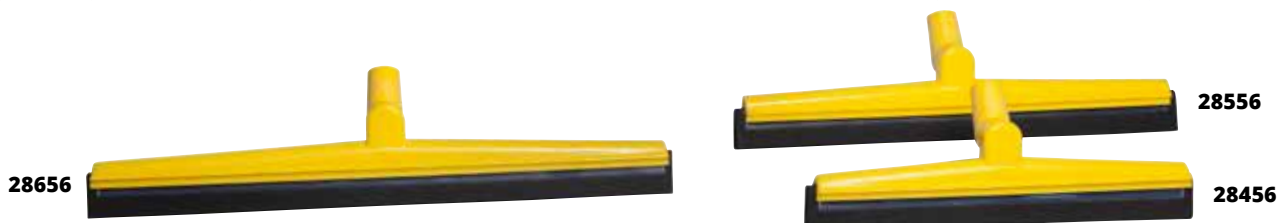

Squeegees with white or black rubber

Soft durable sponge rubber white or black.
Weiches langlebiges Moosgummi in weiß oder schwarz.
Alle skrabere fremstilles med hvidt eller sort gummi.
Mousse blanche ou noire resistente.



Brushes and handles

Replacement rubber

Ersatzgummi | Erstatningsgummi | Recharge Mousse pour raclette

28413-	400 mm	Rubber blades Doppelte Gummilippe Dobbelt gummiblad Lames de mousse		1	6
28513-	500 mm	Rubber blades Doppelte Gummilippe Dobbelt gummiblad Lames de mousse		1	6
28613-	600 mm	Rubber blades Doppelte Gummilippe Dobbelt gummiblad Lames de mousse		1	6
28713-	700 mm	Rubber blades Doppelte Gummilippe Dobbelt gummiblad Lames de mousse		1	6



Floor scraper

Bodenschaber | Gulvskraber | Grattoir

28281-	270 x 110 mm	Steel 304	↓ 110		1	2	3	4	5	6	7	8	11	12
28282-	270 x 110 mm	FLEX Steel 304	↓ 110		1	2	3	4	5	6	7	8		
28283-	270 x 110 mm	Polypropylene Polypropylen PPN Polypropylene Polypropylène	↓ 110		1	2	3	4	5	6	7	8		
28080-	80 mm	FLEX Steel 304	Medium, 1 → 0,5		1	2	3	4	5	6	7			
28120-	120 mm	FLEX Steel 304	Medium, 1 → 0,5		1	2	3	4	5	6	7			
28082-	80 mm	Stiff Steel 304	Stiff, 1 mm steel		1	2	3	4	5	6	7			
28122-	120 mm	Stiff Steel 304	Stiff, 1 mm steel		1	2	3	4	5	6	7			

1,5 mm stainless steel | 1,5 mm acier inoxydable | 1,5 mm rustfrit stål | 1,5 mm acier inoxydable

Paddle scraper blade

Rührlöffelblatt | Paddelskraberblad | Racloir pour sol, lame inox

28290-	112 x 235 mm	Polypropylene Polypropylen PPN Polypropylene Polypropylène		1	2	3	4	5	6	7	8	11	12
28291-	112 x 235 mm	Polyethylene PE		1									

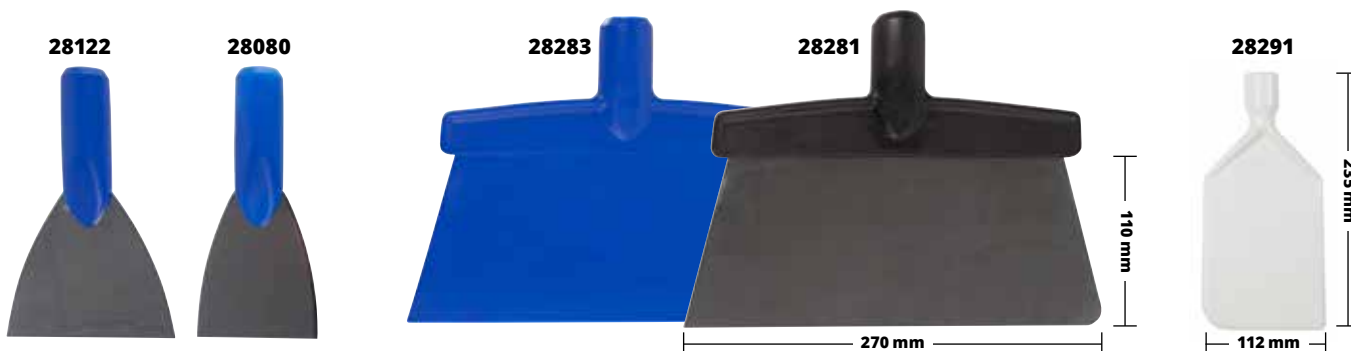

Brushes and handles

Ergonomic handles, aluminium

Aluminiumstiele, ergonomische Form | Aluskafter m/ergonomisk håndgreb
 Manches aluminium , ergonomiques

29812-	650 x 32 mm		1	2	3	4	5	6	7	8	9	11	12
29813-	1300 x 32 mm		1	2	3	4	5	6	7	8	9	11	12
29814-	1500 x 32 mm		1	2	3	4	5	6	7	8	9	11	12
29815-	1750 x 32 mm		1	2	3	4	5	6	7	8	9	11	12



Handles with standard grip, aluminium

Aluminiumstiele, Standard-Handgriff | Aluskafter m/ standard håndgreb
 Manches aluminium avec bi matière pour préhension

29801-	300 x 25 mm		1	2	3	4	5	6	7	8	9	11	12
29802-	800 x 25 mm		1	2	3	4	5	6	7	8	9	11	12
29803-	1300 x 25 mm		1	2	3	4	5	6	7	8	9	11	12
29804-	1500 x 25 mm		1	2	3	4	5	6	7	8	9	11	12
29805-	1750 x 25 mm		1	2	3	4	5	6	7	8	9	11	12

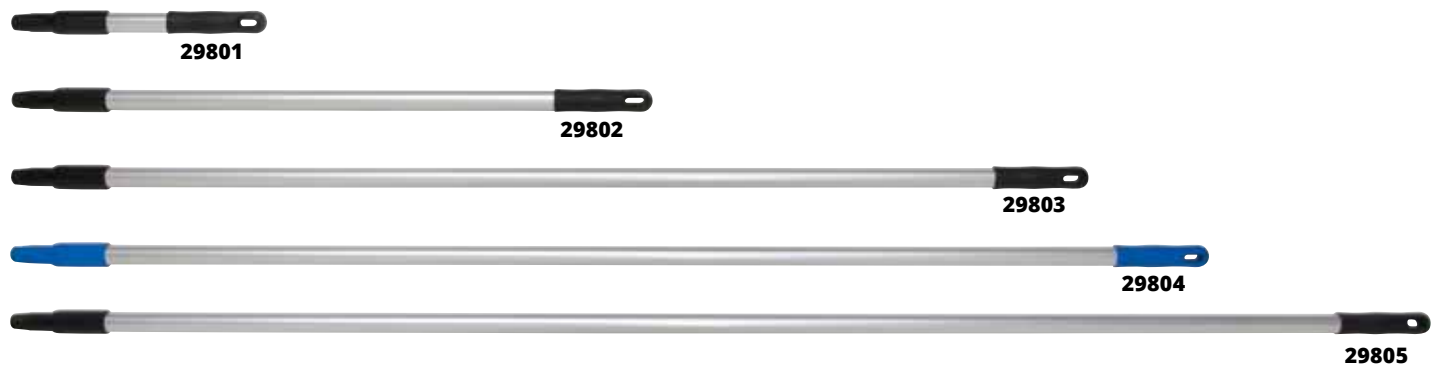

Ergonomic handles

Ergonomic design
 Ergonomische Ausführung
 Ergonomisk design
 Design ergonomique



Standard handgrip

Standard handgrip
 Standard-Handgriff
 Standard håndgreb
 Poignée standard



Aluminium - Alloy 5449

Made from seam welded 1,5 mm wall top grade aluminium tube for strength, anodised for better resistance.
 Gefertigt aus 1,5 mm starkem Aluminiumrohr, Naht verschweißt und eloxiert für eine bessere Beständigkeit gegenüber Flüssigkeiten etc.
 Lavet af 1,5 mm godstykkeelse, anodiseret aluminium.
 Fait en tube aluminium anodisé - soudure d'une épaisseur de 1,5 mm pour une meilleure résistance.

Brushes and handles

Handles with standard grip, fiberglass

Glasfaserstiele, Standard | Glasfiberskafter, alm. håndgreb | manches en fibre de verre avec poignée standard

29704-	1500 x 25 mm	Light weight 1,5 mm wall Gewichtsoptimiert, 1,5mm Wandstärke 1,5 mm godstykkelse Fibre de verre: Poids léger, épaisseur de 1,5 mm		2
29705-	1750 x 25 mm	Light weight 1,5 mm wall Gewichtsoptimiert, 1,5mm Wandstärke 1,5 mm godstykkelse Fibre de verre: Poids léger, épaisseur de 1,5 mm		2



29704



29705

Ergonomic handles, fiberglass

Glasfaserstiele, ergonomische Form | Glasfiberskafter m/ergonomisk håndgreb
Manches ergonomiques en fibre de verre

29713-	1300 x 32 mm	Ergonomic design Ergonomische Ausführung Ergonomisk design Design ergonomique		1 2 3
29714-	1500 x 32 mm	Ergonomic design Ergonomische Ausführung Ergonomisk design Design ergonomique		1 2 3
29715-	1750 x 32 mm	Ergonomic design Ergonomische Ausführung Ergonomisk design Design ergonomique		1 2 3



29713



29714



29715

One-piece ergo. handles

Einteilige, ergonomische Stiele, sehr hygienisch | Fuldstøbt ergonomisk skaft, super hygiejnisk
Manches ergonomiques une pièce, très hygiénique

29903-	1300 x 32 mm	Full coloured Vollfarbig Fuldstøbt Mono couleur		1 2 3 4 5
29904-	1500 x 32 mm	Full coloured Vollfarbig Fuldstøbt Mono couleur		1 2 3 4 5 6 7 8
29905-	1700 x 32 mm	Full coloured Vollfarbig Fuldstøbt Mono couleur		1 2 3 4 5



29903



29904



29905



FDA approved, light weight one-piece molded handle

- Very hygienic, easy to clean, Ergonomic, made with glasfiber
- Can be used with acid and chlorine containing agents from 2-10,5 pH

FDA-genehmigt, gewichtsoptimierter, einteilig geformter Griff

- sehr hygienisch, einfach zu reinigen, ergonomisch, aus Glasfiber
- resistent gegenüber Säuren und chlorhaltigen Reinigungsmitteln mit PH-Wert 2 - 10,5

FDA Godkendt, fuldstøbt let-vægts skaft

- Top hygiensk, rengøringsvenlig, ergonomisk, glasfiberforstærket
- Tåler kemikalier fra 2-10,5 pH

Le seul manche aussi léger et d'une pièce au monde, conforme à la FDA:

- Très hygiénique, facile à nettoyer, ergonomique, fait en fibre de verre
- Peut être utilisée avec de l'acide ou de la chlorine (dont le pH est contenu entre 2 et 10,5)

Brushes and handles

Telescopic handles, fiberglass

Teleskopstiele, Glasfaser | Teleskopskafter, glasfiber | Manche telescopique en fibre de verre

29755-	1100 → 1900 x 26 mm		2
29756-	1500 → 2800 x 26 mm		2
29758-	2500 → 4800 x 26 mm		2



Telescopic handles

Teleskopstiele, extra lang | Teleskopskafter | Manches telescopiques

29775	1600 → 5300 x 34 mm	
29779	1900 → 9500 x 46 mm	



Ergonomic telescopic handles, aluminium

Teleskopstiele, Aluminium, ergonomische Form | Teleskopskafter, ergonomisk, aluminium
Manche telescopique ergonomique en aluminium

29852-	1250 → 2000 x 32 mm		1	2	3	4	5
29856-	1700 → 2800 x 32 mm		1	2	3	4	5

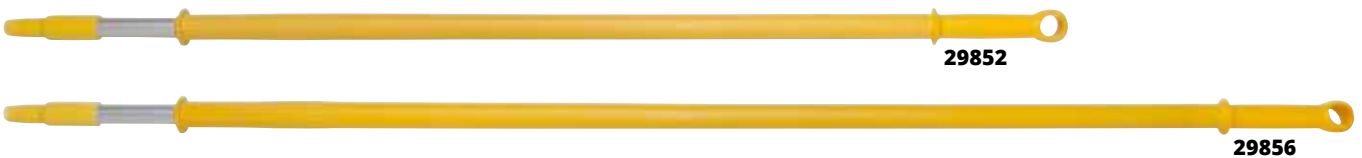

29755 + 29756 + 29758

White with blue handgrip
Weiß mit blauem Handgriff
Hvid med blå håndgreb
Avec bi matière bleue

29775 + 29779

Extra strong with a strong lock, fibreglass.
Extra stærk med festem Verschluss, Glasfaser.
Ekstra stærk konstruktion og kraftig rør i glasfiber, effektiv låsesystem.
Fibre de verre, manches très solides avec un serrage fort.

29852 + 29856

Ergonomic design
Ergonomische Ausführung
Ergonomisk design
Design ergonomique

Hand brushes and hygiene tools

Churn brushes

Stielbürsten breit | Spandebørster, alm. | Brosses avec manche court

10547-	275 x 70 mm	Polyester PBT 0.30	145		1	
10546-	275 x 70 mm	Polyester PBT 0.30	135		1	
10548-	275 x 70 mm	Polyester PBT 0.50	135		1	
10549-	275 x 70 mm	Polyester PBT 0.50	135/50		1	



Churn brushes with rubber handgrip

Stielbürsten breit mit rutschfestem Griff | Spandebørster m/gummikant | Brosse avec manche bi matière

50104-	275 x 70 mm	Polyester PBT 0.30	145		1	
50144-	275 x 70 mm	Polyester PBT 0.30	135		1	
50154-	275 x 70 mm	Polyester PBT 0.50	135		1	

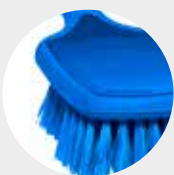

50104 + 50144 + 50154

Colour coded rubber edges bonded to brush body to protect delicate surfaces from damage whilst water brushing, also gives a better hand grip.

Die Gummikanten sind in der Farbe des Bürstenkörpers. Sie schützen empfindliche Gegenstände.

Blød farvekodet gummikant modvirker skader på følsomme overflader.

Contour de la semelle en bimatière pour éviter d'endommager les surfaces délicates pendant le nettoyage, et pour une meilleure prise en main.



10549

New design, more ergonomic handgrip, longer filaments in the tip for better cleaning in corners.

Neue Form, für eine bessere Handhabung. Der längere Schnitt der Borsten erleichtert das Reinigen in schwierigen Ecken.

Nyt design, mere ergonomisk håndgreb, længere filamenter i front, for mere effektiv rengøring i hjørner.

Nouveau design, avec manche ergonomique, fibres plus longues à l'extrémité pour nettoyer dans les coins.

Hand brushes and hygiene tools

Long wide utility brushes

Stielbürsten lang, breite Form | Bred spandebørster m/langt skaft | Brosse large avec manche long

10231-	410 x 55 mm	Polyester PBT 0.30	150		1	2 3
10232-	410 x 55 mm	Polyester PBT 0.30	150		1	2 3 4 5
10233-	410 x 55 mm	Polyester PBT 0.50	150		1	2 3 4 5
10234-	410 x 55 mm	Polyester PBT 0.20/50	150		1	2 3 4 5



Long utility brushes

Stielbürsten lang | Spandebørster, lang | Brosses avec manche long

10214-	410 x 45 mm	Polyester PBT 0.30	145		1	2 3 4 5
10213-	410 x 45 mm	Polyester PBT 0.30	140		1	2 3 4 5 7 8
10215-	410 x 45 mm	Polyester PBT 0.50	140		1	2 3 4 5 7 8 9 11 12



10234

Stiff filaments in the front to help remove stubborn dirt.
 Harte Borsten an der Stirnseite der Bürste lösen hartnäckigen Schmutz zu.
 Stive filamenter i front, for nemmere fjernelse af fastsiddende snavs.
 Fibres à l'avant pour enlever la saleté.

Long wide utility brushes
 in Detectable range see
 page 37

in Resin-Set see page 44

Hand brushes and hygiene tools

Hand scrub brushes

Waschbürsten | Skurebørster | Brosses à laver

15064-	210 x 70 mm	Polyester PBT 0.30	135		1	
15063-	210 x 70 mm	Polyester PBT 0.50	135		1	
15065-	210 x 70 mm	Polyester PBT 0.50	130/40		1	
54153-	210 x 65 mm	Polyester PBT 0.50	130		1	



Hand scrub brushes

Waschbürsten | Skurebørster | Brosses à laver

15067-	180 x 60 mm	Polyester PBT 0.30	130		1	
15062-	180 x 60 mm	Polyester PBT 0.50	130		1	

Round hand scrub brush

Topfbürsten rund | Runde skurebørster | Brosses à laver rondes

54134-	ø 125 mm	Polyester PBT 0.30	140		1	
54154-	ø 125 mm	Polyester PBT 0.50	140		1	



15065

Extended end filaments assist cleaning into angles and difficult corners.
 Mit Bart, für die Reinigung in schwerzugänglichen Ecken.
 Længere filamenter i kanterne, for mere effektiv rengøring i hjørner.
 Fibres plus longues aux extrémités pour un meilleur nettoyage dans les endroits difficiles d'accès.

**For hand scrub brushes
 in Detectable range see
 page 37**

in Resin-Set see page 44

Hand brushes and hygiene tools

Dish washing brushes

Geschirrspülbürsten | Opvaskebørster | Brosses à vaisselle

10462-	255 x 28 mm	Polyester PBT 0.30	125		1	2	3	4	5		
10463-	255 x 28 mm	Polyester PBT 0.30	125		1	2	3	4	5	7	9
10467-	225 x 35 mm	Polyester PBT 0.30	125		1	2					
10466-	225 x 35 mm	Polyester PBT 0.30	125		1	2	3	4	5		

Nail brushes

Nagelbürsten | Neglebørster | Brosses à ongles

15060-	110 x 45 mm	Polyester PBT 0.30	116		1	2	3	4	5	7
15061-	110 x 45 mm	Polyester PBT 0.50	116		1	2	3	4	5	7



Heat resistance range 250°C

Hitzebeständigkeit bis 250°C | Ekstra varmebestandig børster 250°C | Gamme haute resistance a la chaleur 250°C

60153-	275 x 20 mm	PEEK 0.40	130							7
60215-	410 x 45 mm	PEEK 0.40	130							7



10462 + 10463

Effective working area of resilient filaments + scraping edge to remove stubborn residues.
 Saubere Ergebnisse durch elastische Borsten. Mit der Schabekante der Geschirrspülbürste, läßt sich selbst hartnäckiger Schmutz entfernen.
 Med skrabekant - for nemmere fjernelse af fastsiddende snavs.
 Fibres résistantes et rebord grattant pour éliminer les résidus tenaces.



Hand brushes and hygiene tools

Bread and flour brush

Brotstreicher und Mehlbesen | Bageri brød- og melbørste | Brosse pour farine et la pain

51126-	410 x 55 mm	Polyester PBT 0.20	1 60		1	2	3	4	5
52126-	300 x 20 mm	Polyester PBT 0.20	1 60		1	2	3	4	5

Glazing brushes

Lebensmittelpinsel | Bagerpensler | Pinceaux pour la patisserie

80125-	30 mm	Polyester PBT 0.15	1 50		1	2	3
81125-	50 mm	Polyester PBT 0.15	1 50		1	2	3
82125-	70 mm	Polyester PBT 0.15	1 50		1	2	3



Tube cleaners

Wolfbürsten | Kødhakkebørster | Brosses pour tuyauteri

57156-	ø 63 x 80 x 370 mm	Polyester PBT 0.30	1 20		1	2	3	4	5	
57159-	ø 90 x 80 x 370 mm	Polyester PBT 0.50	1 35		1	2	3	4	5	6

Cutter brush

Kutterbørste | Knivbørste | Brosse pour lame

50155-	510 x ø 100 mm	Polyester PBT 0.50	1 45		1	2	3	4	5
--------	----------------	--------------------	------	--	---	---	---	---	---

Small machine/fish brush

Maschinen-/Fischbørste | Lille maskin-/fiskebørste | Brosse étroite pour machine ou poisson

50153-	275 x 20 mm	Polyester PBT 0.50	1 30		1	2	3	4	5	7
--------	-------------	--------------------	------	--	---	---	---	---	---	---



Hand brushes and hygiene tools

Drain cleaning brush

Abflussreinigungsbürste | Overløbsrenser | Brosse pour drains

10745-	ø 15 x 140 x 300 mm	Polyester PBT 0.20		2
--------	---------------------	--------------------	--	---

Tube/bottle brushes with tuft

Flaschenbürsten mit Borstenkranz | Rensere, ombøjjet spids | Goupillons pour tubes ou bouteilles avec embout arrondi

10713-	ø 55 x 140 x 450 mm	Polyester PBT 0.30		1	2
10714-	ø 65 x 160 x 500 mm	Polyester PBT 0.30		1	2

Tube/bottle brushes

Flaschenbürsten | Rensere, alm | Goupillons pour tubes ou bouteilles

10750-	ø 10 x 150 x 500 mm	Polyester PBT 0.20		1	2	3	4	5	7	8				
10752-	ø 20 x 150 x 500 mm	Polyester PBT 0.30		1	2	3	4	5	7	8	9			
10754-	ø 30 x 150 x 500 mm	Polyester PBT 0.30		1	2	3	4	5	7	8	9	11	12	
10756-	ø 40 x 150 x 500 mm	Polyester PBT 0.30		1	2	3	4	5	7	8	9	11	12	
10758-	ø 50 x 150 x 500 mm	Polyester PBT 0.50		1	2	3	4	5	7	8	9	11	12	
10759-	ø 60 x 150 x 500 mm	Polyester PBT 0.50		1	2	3	4	5	7	8	9	11	12	



Hand brushes and hygiene tools

Tube brushes

Rohrbürsten | Rensere m/gevind | Balais tubés

10771-	ø 12 x 100 x 160 mm	Polyester PBT 0.20	M6 thread		1	2	3	4	5
10772-	ø 20 x 100 x 160 mm	Polyester PBT 0.30	M6 thread		1	2	3	4	5
10774-	ø 40 x 100 x 160 mm	Polyester PBT 0.30	M6 thread		1	2	3	4	5
10775-	ø 50 x 100 x 160 mm	Polyester PBT 0.50	M6 thread		1	2	3	4	5
10776-	ø 60 x 100 x 160 mm	Polyester PBT 0.50	M6 thread		1	2	3	4	5
10778-	ø 80 x 100 x 160 mm	Polyester PBT 0.50	M6 thread		1	2	3	4	5

Rods with thread

Stiele mit Gewinde | Wire, stål og nylon | Manches avec pas de vis

10780	150 cm	Flexible rod Flexible Stiele Fleksibelt skaft Tige flexible Stainless wire Edelstahldraht Rustfri Acier inoxydable		
10781	300 cm	Flexible rod Flexible Stiele Fleksibelt skaft Tige flexible Stainless wire Edelstahldraht Rustfri Acier inoxydable		
10784	150 cm	Flexible rod Flexible Stiele Fleksibelt skaft Tige flexible Nylon rod Nylon Stiele/ Nylon skaft Tige en nylon		1
10785	150 cm	Extension rod Verlängerungsstiel Forlænger skaft Rallonge Nylon rod Nylon Stiele/ Nylon skaft Tige en nylon		1

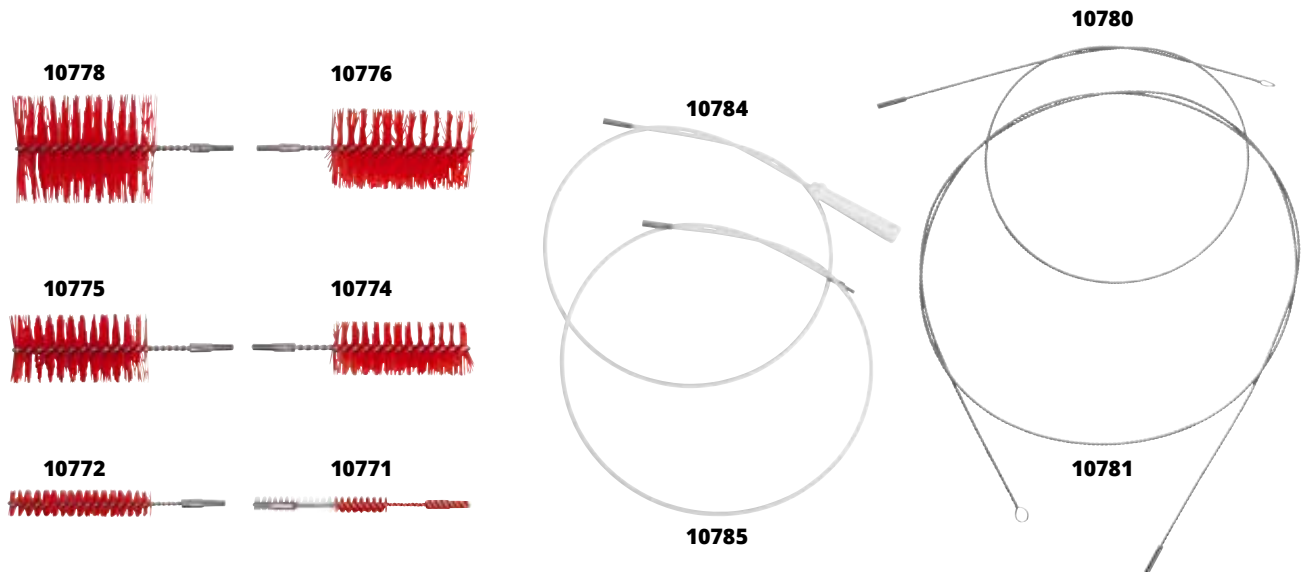

For all tube brushes, bottle brushes and rods

Twisted stainless steel wire, looped coil at the working end avoiding damage from abrasive cut ends of wire core.

Gedrehter Edelstahldraht, die Drahtenden sind umgebogen um Schäden vorzubeugen.

Snoet rustfrit stålwire, med rund spids som modvirker ridser og skader i følsomme overflader. (Speciel størrelse kan fremstilles efter ønske).

Acier inoxydable, embout torsadé à l'extrémité afin d'éviter tout dommage.

Hand brushes and hygiene tools

Spatulas

Spachtel | Spärtler | Spatules

15109-	110 x 250 mm	Polypropylene Polypropylen PPN Polypropylene Polypropylène		1	2	3	4	5	6	7	8	9	11	12
82904-	75 x 250 mm	Polypropylene Polypropylen PPN Polypropylene Polypropylène		1	2	3	4	5				9	11	12

Ergo. scrubber

Ergonomische Spachtel | Ergonomisk skraber | Spatule ergonomique

81900-	200 x 125 mm	Polypropylene Polypropylen PPN Polypropylene Polypropylène		1	2	3	4	5					11	12
--------	--------------	------------------------------------------------------------------	--	---	---	---	---	---	--	--	--	--	----	----

With 3 working sides | Mit 3 Arbeitsflächen | Med 3 arbejdsider | Peut être utilisée sur 3 côtés.

Ergo. spatula

Ergonomische Spachtel | Ergonomisk spartel | Spatule ergonomique

82900-	100 x 240 mm	Polypropylene Polypropylen PPN Polypropylene Polypropylène		1	2	3	4	5					11	12
--------	--------------	------------------------------------------------------------------	--	---	---	---	---	---	--	--	--	--	----	----

With 2 working sides | Mit 2 Arbeitsflächen | Med 2 arbejdsider | Peut être utilisée sur 2 côtés.

Spatulas, nylon (250°C)

Spachteln, Nylon (250°C) | Spärtler, nylon (250°C) | Spatules, nylon (250°C)

82911-6	110 x 250 mm	Nylon											6	
82910-6	75 x 250 mm	Nylon											6	

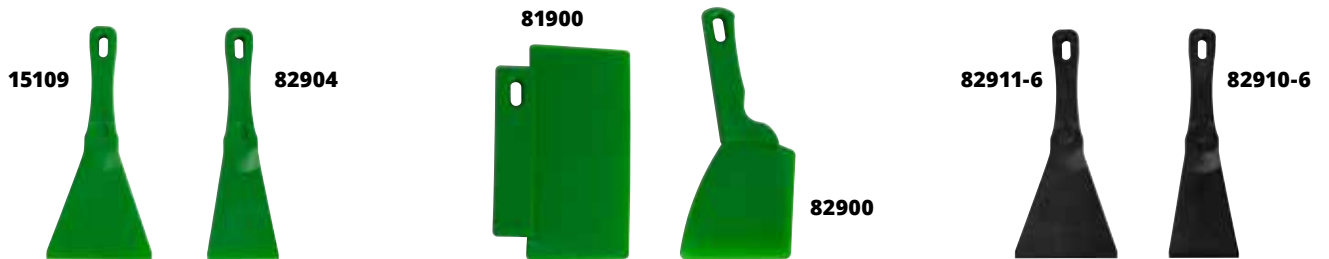

Stainless steel spatulas with PP handle

Edelstahlspachteln mit PP-Griff | Rustfri spärtler med PP håndtag | Spatules inoxydables avec manche en PP

88040-	40 mm	Steel 304	Medium, 1 → 0,5		1	2	3	4	5		7	8		
88080-	80 mm	Steel 304	Medium, 1 → 0,5		1	2	3	4	5		7	8		
88100-	120 mm	Steel 304	Medium, 1 → 0,5		1	2	3	4	5		7	8		
88042-	40 mm	Steel 304	Stiff, 1 mm steel		1	2	3	4	5	6	7	8		
88082-	80 mm	Steel 304	Stiff, 1 mm steel		1	2	3	4	5	6	7	8		
88102-	120 mm	Steel 304	Stiff, 1 mm steel		1	2	3	4	5	6	7	8		



Hand brushes and hygiene tools

Large hand scoop

Große Handschaufel | Stor håndskovl | Pelle manche long

80305-	270 x 320 x 540 mm	Polypropylene Polypropylen PPN Polypropylene Polypropylène		1	2	3	4	5	6	7	8	9	11	12
--------	--------------------	------------------------------------------------------------------	--	---	-------------------	-------------------	-------------------	-------------------	-------------------	-------------------	-------------------	-------------------	--------------------	--------------------

Hand scoops

Handschaufeln | Håndskovle | Pelle à main

15105-	110 x 150 x 265 mm	Small 500 gram Polypropylene	0,75 liter litres		1	2	3	4	5	6	7	8	9	11	12
15106-	135 x 185 x 310 mm	Medium 750 gram Polypropylene	1,5 liter litres		1	2	3	4	5	6	7	8	9	11	12
15107-	160 x 230 x 360 mm	Large 1000 gram Polypropylene	2,5 liter litres		1	2	3	4	5	6	7	8	9	11	12

Dust pan

Kehrschaufel | Fejebld | Pelle

80301-	300 x 310 mm	Polypropylene Polypropylen PPN Polypropylene Polypropylène		1	2	3	4	5	6	7	8	9	11	12
--------	--------------	------------------------------------------------------------------	--	---	-------------------	-------------------	-------------------	-------------------	-------------------	-------------------	-------------------	-------------------	--------------------	--------------------

Very strong | Sehr stabil | Meget stærk | Très résistante

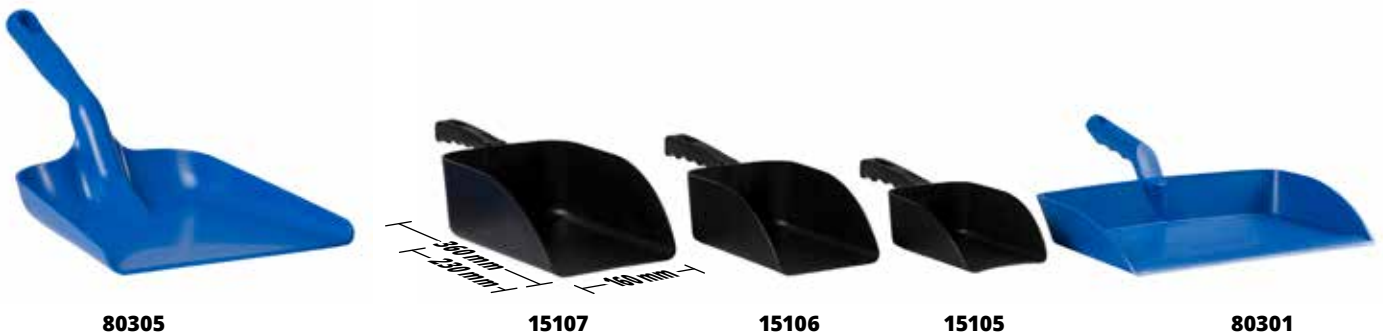

Dough scraper with hole

Teigschaber mit Loch | Dejskraber med hul | Râcloir à pâte avec trou

81910-	146 x 98 mm	Polypropylene Polypropylen PPN Polypropylene Polypropylène		1	2	3	4	5	6	7	8
81915-	160 x 125 mm	Polypropylene Polypropylen PPN Polypropylene Polypropylène		1	2	3	4	5	6	7	8

Dough scraper

Teigschaber | Dejskraber | Râcloir à pâte

81911-	146 x 98 mm	Polypropylene Polypropylen PPN Polypropylene Polypropylène		1	2	3	4	5	6	7	8
81916-	160 x 125 mm	Polypropylene Polypropylen PPN Polypropylene Polypropylène		1	2	3	4	5	6	7	8

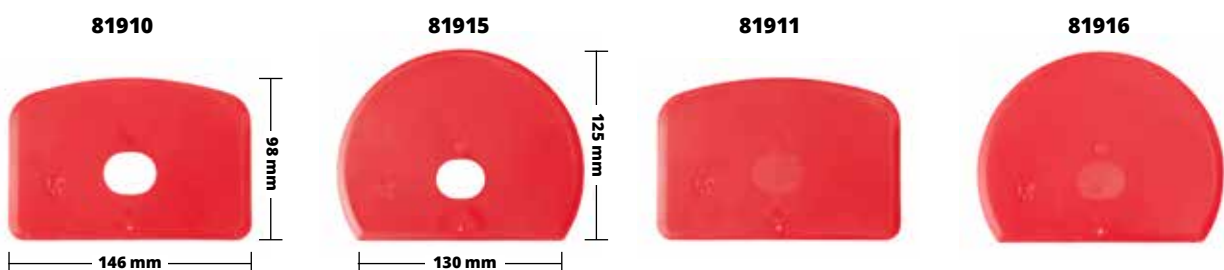

Hand brushes and hygiene tools

Bucket & lid

The bucket and lid for production, ingredients and washdown that the industry can't live without!

Functional, ergonomic and very hygienic:

- Large 15 Ltr. and 9 Ltr. Capacity. Inside graduations in Litres and UK/US Gallons
- Molded in food grade polypropylene
- Special designed pouring lip, heavy duty rim and storage function
- Hand-grip on back of bucket for easy pouring - big enough for gloved hands and high enough off floor to avoid scraping knuckles
- Strong, comfortable polypropylene handle
- Easy to clean – smooth surfaces, no internal or external sharp angles

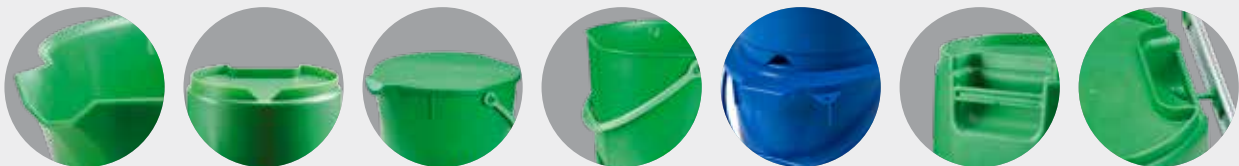

Funktional, ergonomisk og sehr hygienisch:

- großes Fassungsvermögen von 15 und 9 Litern, innenliegende Skala in Litern und UK/US-Gallonen
- hergestellt aus lebensmittelechtem Polypropylen
- speziell geformter Ausgusschnabel, äußerst stabiler Rand und Stapelfunktion
- Handgriff an der Unterseite zum einfacheren Ausgießen; mit ausreichender Bodenfreiheit, um Schürfwunden an den Fingerknöcheln zu verhindern
- robuster, ergonomischer Polypropylengriff
- einfach zu reinigen durch glatte Oberflächen, keine scharfen Kanten an der Innen- oder Außenseite

Funktionel, ergonomisk & top hygiejnisk:

- 15 L og 9 L volumen. Indvendig mål i Liter og UK/US Gallon. Produceret i FDA godkendt materiale
- Speciel designet hældekanal, robustkant og ophængsfunktion
- Ekstra håndtag nederst på spanden gør det muligt at få fat uden at skrabe knoerne
- Bekvemmelig og stærk hank i polypropylene
- Unik hygiejnisk design – let rengørlig uden skarpe kanter

Fontionnel, ergonomique et très hygiénique:

- capacité de 15L. & 9 L. graduations intérieures en Litres ET en gallons GB/USA.
- moulu en polypropylène avec contact alimentaire
- bec verseur spécial, bords gros travaux et facile à ranger
- encoche pour main sur le dessous du seau pour un versage facile - assez haut du sol pour éviter les douleurs articulaires
- poignée polypropylène confortable et résistante
- facile à nettoyer - surfaces lisses, pas d'angle aigu interne ou externe

Bucket

Eimer | Spand | Seau

80101-	15 liter 15 litres	Polypropylene Polypropylen PPN Polypropylene Polypropylène		1	2	3	4	5	6	7	8	9	11	12
80102-	9 liter 9 litres	Polypropylene Polypropylen PPN Polypropylene Polypropylène		1	2	3	4	5	6	7	8	9	11	12

Lid for bucket

Deckel | Låg til spand | Couvercle pour seau

80111-	15 liter 15 litres	Polypropylene Polypropylen PPN Polypropylene Polypropylène		1	2	3	4	5	6	7	8	9	11	12
80112-	9 liter 9 litres	Polypropylene Polypropylen PPN Polypropylene Polypropylène		1	2	3	4	5	6	7	8	9	11	12

Hand brushes and hygiene tools

Lobby pan and dust pan with lid/grip

Lobby pan & dust pan with lid/grip

- Strong heavy duty design
- Capacity for 7 Ltr.
- High capacity for dry waste and easy to clean
- Fits to FBK wall holder system
- Can hang upside down for drying

Lobby pan:

- 1050 mm incl. handle. Ergonomic designed

Dust pan with lid/ handgrip:

- Designed with holder for either bannister brush or hand squeegee



80201-



80205-



80203-

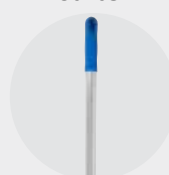

80204-



Kehrbehälter mit Stiel / Kehrbehälter mit Henkel:

- Äußerst robust und stabil
- Fassungsvermögen ca. 7 Liter
- Länge 1.050 mm inkl. Griff, ergonomisch geformt
- Großes Fassungsvermögen für trockene Abfälle, einfach zu reinigen
- kompatibel zum FBK-Wandhaltesystem

Fejebakke til skaft & med håndtag:

- Kraftig og stabilt design
- Kapacitet på 7 L
- 1050 mm inkl. skaft. Ergonomisk design
- Hygiejnisk - let rengørlig
- Integreret ophæng funktion

Pelle aéroport avec couvercle et manche:

- Design orienté gros travaux
- Capacité de 7L.
- 1050mm dont manche. Design ergonomique.
- Haute capacité pour déchets secs et facile à nettoyer
- Compatible avec le système d'attache mural FBK

Lobby pan without handle

Kehrschaufel ohne Stiel | Fejebakke uden skaft | Manche la pelle aéroport

80201-	Polypropylene Polypropylen PPN Polypropylene Polypropylène		1	2	3	4	5	6	7	8	9	11	12
--------	------------------------------------------------------------------	--	---	---	---	---	---	---	---	---	---	----	----

Lightweight handle and clip for lobby pan

Griff und Clip für Kehrbehälter | Skaft og holder til fejebakke | Manche et système d'attache mural

80203-	800 x 25 mm	Thickness: 0,9 mm aluminium		1	2	3	4	5	6	7	8	9	11	12
80204-	PPN	Clip Clip Holder Clip		1	2	3	4	5	6	7	8	9	11	12

Dust pan with lid and handgrip

Kehrschaufel mit Handgriff inkl. Befestigung für Handfeger oder Handabzieher

Fejebakke med låg og håndgreb | Réservoir avec couvercle/poignée + support pour raclette ou balayette

80205-	Polypropylene Polypropylen PPN Polypropylene Polypropylène		1	2	3	4	5	6	7	8	9	11	12
--------	------------------------------------------------------------------	--	---	---	---	---	---	---	---	---	---	----	----

Hand brushes and hygiene tools

Ergonomic one-piece shovels, short handle

Ergonomische Schaufeln, einteilig mit kurzem Stiel | Ergonomisk kortskaftede skovle
 Pelle ergonomique avec manche, manche court

14103-	270 x 340 x 1120 mm	Polypropylene Polypropylen PPN Polypropylene Polypropylène		1	2	3	4	5	6	7	8	9	11	12
14104-	330 x 380 x 1120 mm	Polypropylene Polypropylen PPN Polypropylene Polypropylène		1	2	3	4	5	6					

Ergonomic one-piece shovels, long handle

Ergonomische Schaufeln, einteilig mit langem Stiel | Ergonomisk langskaftede skovle
 Pelle ergonomique avec manche long

15103-	270 x 340 x 1330 mm	Polypropylene Polypropylen PPN Polypropylene Polypropylène		1	2	3	4	5	6					
15104-	330 x 380 x 1330 mm	Polypropylene Polypropylen PPN Polypropylene Polypropylène		1	2	3	4	5	6	7				



14103 + 14104 + 15103 + 15104

One piece moulded provide proven, robust work tools, light weight, easily cleaned, non abrasive and rot proof.

Aus einem Stück gespritzte Schaufeln, sind robuste Arbeitsgeräte, die ein geringes Gewicht haben und leicht zu reinigen sind.

Meget stærkt fuldstøbt design. Ergonomisk og hygiejnisk. Tåler ekstrem belastning.

Moulé d'une seule pièce pour être robuste, léger, facile à nettoyer non abrasif.



Strength test

Strength test for ergonomic shovels are available on www.fbk.dk

Infos zum Härtetest für ergonomische Schaufeln sind unter www.fbk.dk verfügbar

Styrketest for ergonomiske skovle er tilgængelig på www.fbk.dk

Les tests de résistance pour les pelles sont disponibles sur www.fbk.dk

Hand brushes and hygiene tools

Single aluminium rails



Aluminiumschienen | Aluminiumsskinne uden ophæng | Rail aluminium

15156-	300 mm	 	1	2	3	4	5	6	7	8	9	11	12
15154-	500 mm	 	1	2	3	4	5	6	7	8	9	11	12
15153-	900 mm	 	1	2	3	4	5	6	7	8	9	11	12



Wall holder sets





Ordnungssysteme für die Wand | Ophængssystem | Système d'accroche mural des ustensiles

15158-	300 mm	2 small 2 kleiner Halter 2 small 2 petits	 	1	2	3	4	5	6	7	8	9	11	12
15155-	500 mm	2 small/1 large 2 kleine Halter/ 1 großer Halter 2 petits/1 large	 	1	2	3	4	5	6	7	8	9	11	12
15157-	900 mm	3 small/2 large 3 kleine Halter/ 2 große Halter 3 petits/2 larges	 	1	2	3	4	5	6	7	8	9	11	12



Wall bracket system

Stahlbefestigungen System | Rustfri stålophæng | Suspension de l'acier

15160	415 mm	FBK logo	4 x hook 4 x haken 4 x krog 4 x crochet	Steel 304	
15161	415 mm		4 x hook 4 x haken 4 x krog 4 x crochet	Steel 304	
15164	580 mm	FBK logo	6 x hook 6 x haken 6 x krog 6 x crochet	Steel 304	
15165	580 mm		6 x hook 6 x haken 6 x krog 6 x crochet	Steel 304	

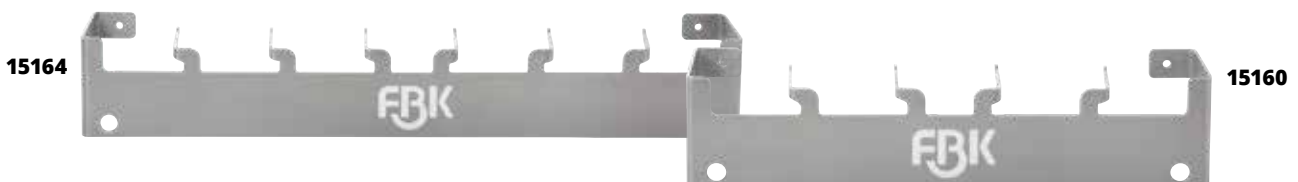

Wall holder

One piece holders without loose parts. Soft rubber grips hold items securely, even when wet. Incl. screws and wall plugs.

Halter aus einem Stück. Weiche gummierte Flächen gewähren sicheren Halt auch bei Nässe. Mit Dübeln und Schrauben.

Effektiv og stærk ophængssystem, en hjælp til at holde orden samt længere levetid af produkterne. Med skruer og rawplugs.

D'une seule pièce. Les bords des crochets tiennent bien les ustensiles même mouillés. Incl. vis et rail mural.

Wall bracket system

Made of 3 mm Steel 304. Heavy duty and safety design.

Hergestelt aus 3 mm Stahl 304. Schwerlast- und Sicherheitskonzept.





Lavet af 3 mm Stå 304. Kraftig og sikkerhedsmæssigt design.

De 3 mm acier 304. Robuste et la conception de la sécurité.

Hand brushes and hygiene tools

Single clip



Halter | Løs ophæng | Clip

15150-	ø 22 - 32 mm	Single clip, small Halter, klein Løs ophæng, lille Clip, petite taille	↔ 77	 	1	2	3	4	5	6	7	8	9	11	12
15151-	ø 28 - 38 mm	Single clip, large Halter, groß Løs ophæng, stor Clip, grande taille	↔ 85	 	1	2	3	4	5	6	7	8	9	11	12



Wallhook, strengthen with fibreglass



Haken, glasfiberverstärkt | Ophængskrog, glasfiber forstærket | Crochet renforcé en fibre de verre

80000-	60 mm		↔ 50	 	1	2	3	4	5	6	7	8	9	11	12
--------	-------	--	------	------------------------------------------------------------------------------------------------------------------------------------------------------------------------	---	---	---	---	---	---	---	---	---	----	----



Sign board for alu.rails



Beschriftungsschild für Aluminiumschienen | Produkt skilte | Marqueur pour rail aluminium

80002-	110 x 75 mm			 	1	2	3	4	5	6	7	8	9	11	12
--------	-------------	--	--	----------------------------------------------------------------------------------------------------------------------------------------------------------------------------	---	---	---	---	---	---	---	---	---	----	----



Replacement end cap for alu.rails

Endkappen für Aluminiumschienen | Erstatnings endestop | Embout pour rail aluminium

80005-				 	1	2	3	4	5	6	7	8	9	11	12
--------	--	--	--	----------------------------------------------------------------------------------------------------------------------------------------------------------------------------	---	---	---	---	---	---	---	---	---	----	----

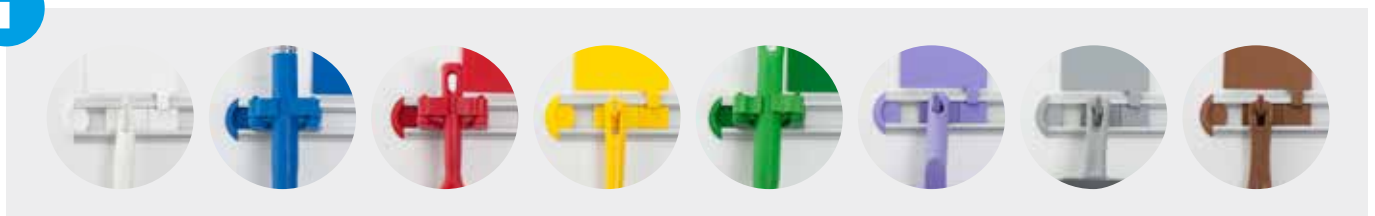

Detectable range



Manufactured from our own formulation involving additives that conform to food contact regulations, this addition allows material that may become accidentally detached from an article in use to be detected by standard in-line metal detection equipment. Appropriate for articles used in both the food and pharmaceutical manufacturing sectors.

METAL + X-RAY
DETECTABLE + DETECTABLE

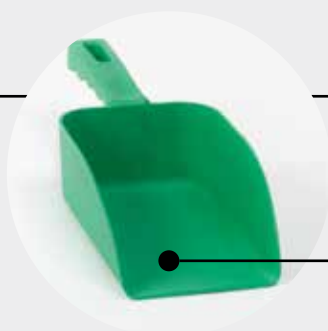

Metal Detectable

A range of sweepers and handbrushes which only the filaments are detectable, not the brush bloc.

Metal + X-ray Detectable

A range of one-piece molded articles as: Spatulas, scraber, bucket, hand scoops, shovels and dustpan.

Metall und X-Ray detektierbare Artikel

Aus unserer eigenen Kunststoffrezeptur unter Zugabe von detektierbaren Additiven hergestellt, die für Lebensmittelkontakt zugelassen sind. Dies ermöglicht, unbemerkt abgetrennte Materialstücke eines Produktes mit Standard Inline-Metalldetektoren und Röntgengeräten zu erkennen. Besonders geeignet für die Lebensmittelindustrie und Hersteller von pharmazeutischen Produkten.

Detekterbare produkter

Et sortiment af produkter som er specielt udviklet for levnedsmiddel- og farmaceutindustrien, hvor kontamination kan være meget omkostningsfuldt både økonomisk og på omdømmet hos den enkelte producent. Specielt fremstillet fødevarer godkendt additiv er tilsat således at emnet bliver detekterbar og selv mindre stykker kan detekteres og afvises inden produktet kommer ud til kunden.

Détection des Métaux

Fabriqué depuis notre propre formule impliquant des additifs conformes aux réglementations alimentaires, permettant aux matériaux qui se détacheraient accidentellement d'un article en cours d'utilisation d'être détectés par un équipement de détection de métal par rayons X. Approprié pour tout article des secteurs alimentaire et pharmaceutique.

Detectable range

METAL
DETECTABLE

Long wide utility brush

Stielbürste lang, breite Form | Spandebørster, lang | Brosse multi usage manche long

70233- 410 x 55 mm Polyester PBT 0.60

1:60



2

Bannister brush

Handfeger | Håndkost | Balayette

70255- 340 x 35 mm Polyester PBT 0.60

1:60



2

Churn brush

Stielbürste breit | Spandebørste | Brosse avec manche court

70548- 275 x 70 mm Polyester PBT 0.60

1:50



2



Flour brush

Mehlbesen | Bageri melbørste | Brosse à farine

72166- 300 x 20 mm Polyester PBT 0.60

1:60



2

Hand scrub brush

Waschbürste | Skurebørster | Brosse à main

75063- 210 x 70 mm Polyester PBT 0.60

1:40



2



i

Tested on a Safeline R-series machine 300 kHz; \varnothing 0.90mm FE = 18mm longitudinal/33mm transverse | Before use, please calibrate test for own safety.

Getestet auf einer Safeline Maschine R-Serie 300 kHz; \varnothing 0.90mm FE = 18mm longitudinal / 33mm transversal | Führen Sie bitte vor dem Gebrauch einen Kalibrierungstest durch. Dies dient Ihrer eigenen Sicherheit.

Testet på en Safeline R-serie maskine 300 kHz; \varnothing 0.90mm FE = 18mm longitudinal/33mm transverse | For en sikkerheds skyld anbefaler vi at man laver en kalibreringstest før brug.

Testé sur une machine Safeline R-serie 300 kHz; \varnothing 0.90mm FE = coupe longitudinale 18mm/coupe transversale 33mm / Avant d'utiliser, veuillez calibrer la machine.

Detectable range



Sweeper

Besen | Fejekoste | Balai droit

71166-	400 x 50 mm	Polyester PBT 0.60	1:55		2
--------	-------------	--------------------	------	--	---

Spanish style sweeper

Besen mit gerader Stielaufnahme (Spanish Style) | Fejekoste (spansk design) | Balai droit (lavage espagnol)

73157-	280 x 48 mm	Polyester PBT 0.60	1:70		2
--------	-------------	--------------------	------	--	---



71166



73157

Stainless steel spatulas with PP handle

Edelstahlpachteln mit PP-Griff | Rustfri spartler med PP håndtag
Spatules inoxydables avec manche en PP



78042-	40 mm	Steel 304	Stiff, 1 mm steel		2	3	4	5
78082-	80 mm	Steel 304	Stiff, 1 mm steel		2	3	4	5
78102-	120 mm	Steel 304	Stiff, 1 mm steel		2	3	4	5

Paddle scraper blade

Rührlöffelblatt | Paddelskraberblad | Racloir pour sol, lame inox

74290-	112 x 235 mm	Polypropylene Polypropylen PPN Polypropylene Polypropylène		2
--------	--------------	------------------------------------------------------------------	--	---



78042



78082



78102



74290

235 mm

112 mm

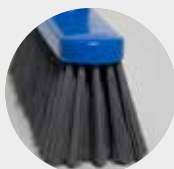
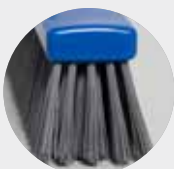

Metal detectable

Only the filaments are metal detectable, not the brush block

Die Borsten sind detektierbar, die Bürstenkörper nicht

Kun filamenterne er metal-detekterbar, ikke selve børstekrop

Seules les fibres sont en métal détectable, pas la semelle de la brosse.



78042 + 78082 + 78102

Detectable handle

Detektierbarer Griff

Detekterbar håndtag

Manche détectable

Detectable range



Spatulas

Spachteln | Skrabere | Spatules

75109-	110 x 250 mm	Polypropylene Polypropylen PPN Polypropylene Polypropylène		2	3	4	5
72904-	75 x 250 mm	Polypropylene Polypropylen PPN Polypropylene Polypropylène		2	3	4	5

Ergo. scraber

Ergonomische Spachtel | Ergonomisk skrabere | Spatule ergonomique

71900-	200 x 125 mm	Polypropylene Polypropylen PPN Polypropylene Polypropylène		2	3	4	5
--------	--------------	------------------------------------------------------------------	--	---	---	---	---

With 3 working sides | Mit 3 Arbeitsflächen | Med 3 arbejdsider | Peut être utilisée sur 3 côtés

Ergo. spatula

Ergonomische Spachtel | Ergonomisk skrabere | Spatule ergonomique

72900-	100 x 240 mm	Polypropylene Polypropylen PPN Polypropylene Polypropylène		2	3	4	5
--------	--------------	------------------------------------------------------------------	--	---	---	---	---

With 2 working sides | Mit 2 Arbeitsflächen | Med 2 arbejdsider | Peut être utilisée sur 2 côtés



Bucket

Eimer | Spand | Seau

70101-	15 liter 15 litres	Polypropylene Polypropylen PPN Polypropylene Polypropylène		2	3	4	5
70102-	9 liter 9 litres	Polypropylene Polypropylen PPN Polypropylene Polypropylène		2	3	4	5

Lid for bucket

Deckel | Låg til spand | Couvercle pour seau

70111-	15 liter 15 litres	Polypropylene Polypropylen PPN Polypropylene Polypropylène		2	3	4	5
70112-	9 liter 9 litres	Polypropylene Polypropylen PPN Polypropylene Polypropylène		2	3	4	5



Detectable range



Hand scoops

Handschaufeln | Håndskovle | Petites Pelles

75105-	110 x 150 x 265 mm	Small 500 gram Polypropylene		2	3	4	5
75106-	135 x 185 x 310 mm	Medium 750 gram Polypropylene		2	3	4	5
75107-	160 x 230 x 360 mm	Large 1000 gram Polypropylene		2	3	4	5

Dust pan

Kehrschaufel | Fejebld | Pelle

70301-	300 x 310 mm	Polypropylene Polypropylen PPN Polypropylene Polypropylène		2	3	4	5
--------	--------------	------------------------------------------------------------------	--	---	---	---	---

Detectable tester

Tester | Tester | Tester

79999-				2			
--------	--	--	--	---	--	--	--



Dough scraper with hole

Teigschaber mit Loch | Dejskraber med hul | Râcloir à pâte avec trou

71910-	146 x 98 x 1.65 mm	Polypropylene Polypropylen PPN Polypropylene Polypropylène		2	3	4	5
71915-	160 x 125 x 1.65 mm	Polypropylene Polypropylen PPN Polypropylene Polypropylène		2	3	4	5

Dough scraper

Teigschaber | Skrabere | Râcloir à pâte

71911-	146 x 98 x 1.65 mm	Polypropylene Polypropylen PPN Polypropylene Polypropylène		2	3	4	5
71916-	160 x 125 x 1.65 mm	Polypropylene Polypropylen PPN Polypropylene Polypropylène		2	3	4	5



Detectable range



Ergonomic one-piece shovels, short handle

Ergonomische Schaufeln, einteilig mit kurzem Stiel | Ergonomisk kortskaftede skovle
 Pelle ergonomique avec manche, manche court

74103-	270 x 340 x 1120 mm	Polypropylene Polypropylen PPN Polypropylene Polypropylène		2	3
74104-	330 x 380 x 1120 mm	Polypropylene Polypropylen PPN Polypropylene Polypropylène		2	3

Ergonomic one-piece shovels, long handle

Ergonomische Schaufeln, einteilig mit langem Stiel | Ergonomisk langskaftede skovle
 Pelle ergonomique avec manche long

75103-	270 x 340 x 1330 mm	Polypropylene Polypropylen PPN Polypropylene Polypropylène		2	3
75104-	330 x 380 x 1330 mm	Polypropylene Polypropylen PPN Polypropylene Polypropylène		2	3

Large hand scoop

Große Handschaufel | Stor håndskovl | Ecope manche long

70305-	270 x 320 x 540 mm	Polypropylene Polypropylen PPN Polypropylene Polypropylène		2	3	4	5
--------	--------------------	------------------------------------------------------------------	--	---	---	---	---



Resin-Set

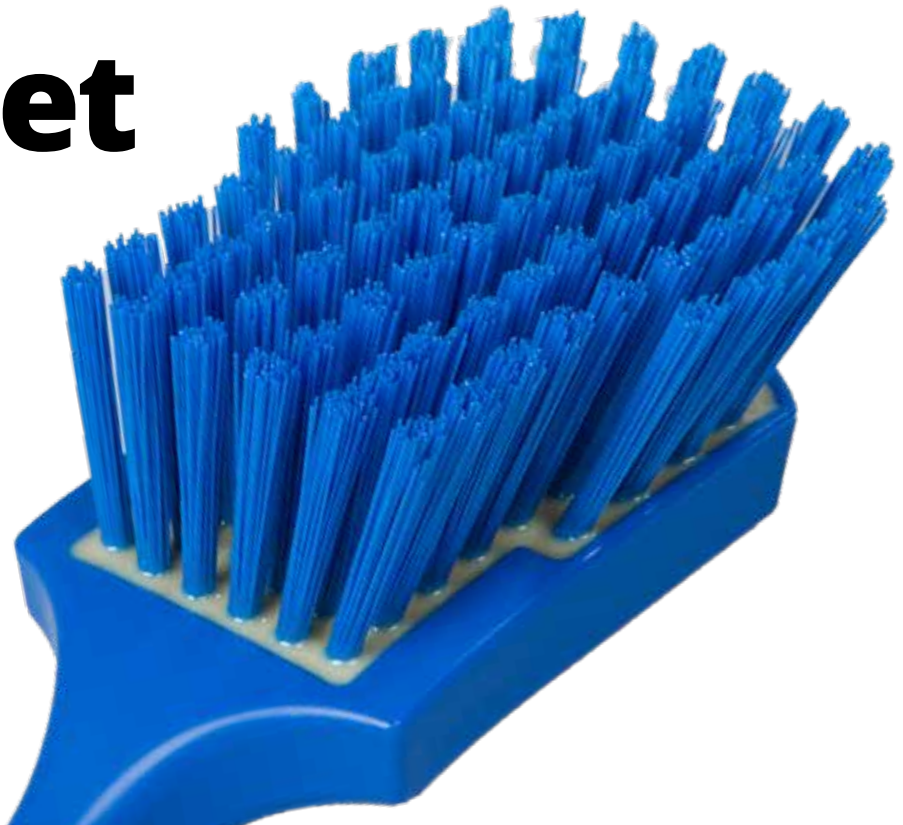

The Resin-Set range is a selection of articles with bristle set in flexible resin compound, made with a unique technic in custommade brush bodies. Filaments are secured with both stainless steel staples + resin which is floated into and around each filament bundle for extra bristle retention.

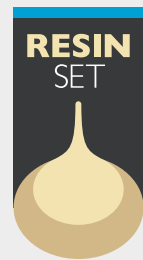

What is Resin-Set?

The Resin-Set articles are made by a two-component molding system, manufactured by FBK Denmark. We recommend usage temperatures from -10 C to 120 C, and autoclavable at temperatures up to 134 C°.

The range of Resin-Set articles:

- washing brushes
- different range of Sweepers
- hand brushes.

Resin-Set

Das Resin-Produktprogramm umfasst eine Auswahl von Artikeln, deren Borsten durch ein spezielles Produktionsverfahren mit flexiblem Resin in dafür eigens gefertigte Bürstenkörper eingegossen werden. Die Borstenbündel werden durch Edelstahlklammern fixiert und anschließend Resin in den Bürstenkörper gegossen. Dadurch sind alle Borsten umschlossen und eine dauerhafte Borstenfixierung sichergestellt.

Resin-Set

Resin-Set er et sortiment af børster, hvor filamenterne bliver limet fast til børstekroppen med en unik teknik i specielt fremstillet emner. Filamenterne er sikret med både rustri stål krampe + lim som flyder omkring og ned i hver borehul, hvilket sikre enkelte filamenter ikke kan trækkes løs, samt minimere risikoen for bakterier i borehullerne.

Set résine

Le Set résine est une sélection d'article dont les fibres sont fixées dans une semelle en résine flexible, fabriquée avec une technique unique et sur-mesure dans le monde de la broserie. Les filaments sont fixés par des agrafes en acier inoxydable et de la résine coulée dans et autour de chaque touffe pour une meilleure rétention des saletés par la fibre.

Sweepers

Besen | Fejekoste | Balais droits

91136-	400 x 50 mm	Polyester PBT 0.30	‡55		1	2	3	4	5	7	8	11	12
91156-	400 x 50 mm	Polyester PBT 0.50	‡55		1	2	3	4	5	7	8	11	12

Spanish style sweepers

Besen mit gerader Stielaufnahme (Spanish Style) | Fejekoste (spansk design) | Balai droit (lavage espagnol)

93147-	280 x 48 mm	Polyester PBT 0.30	‡65		1	2	3	4	5	7	8
93157-	280 x 48 mm	Polyester PBT 0.50	‡65		1	2	3	4	5	7	8



Washing brushes

Waschbürste | Vaskebørster | Brosses à laver

93135-	225 x 60 mm	Polyester PBT 0.30	‡55		1	2	3	4	5	7	8
93155-	225 x 60 mm	Polyester PBT 0.50	‡55		1	2	3	4	5	7	8

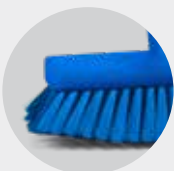

93135 + 93155

Flexible washing brush with Resin-Set, which allows for efficient cleaning of floors, walls and tanks, e.g. Flexible Waschbürsten mit Kunstharz (Resin) zur effizienten Reinigung von Böden, Wänden, Tanks, etc. Flexibel vaskebørster med Resin-Set som giver mulighed for effektiv rengøring i f.eks. Tanke, på væge og gulv Brosse à laver flexible en résine, permettant un lavage efficace des sols, murs ou autres réservoirs.

Long wide utility brushes

Stielbürsten lang, breite Form | Bred spandebørster m/langt skaft | Brosse large avec manche long

90232-	410 x 55 mm	Polyester PBT 0.30	150		1	2	3	4	5	7	8
90233-	410 x 55 mm	Polyester PBT 0.50	150		1	2	3	4	5	7	8

Bannister brushes

Handfeger | Håndkoste | Balayettes

90252-	340 x 35 mm	Polyester PBT 0.30	150		1	2	3	4	5	7	8	11	12
90255-	340 x 35 mm	Polyester PBT 0.50	150		1	2	3	4	5	7	8	11	12



Churn brushes

Stielbürsten breit | Spandebørster, alm. | Brosses avec manche court

90546-	275 x 70 mm	Polyester PBT 0.30	140		1	2	3	4	5	7	8	11	12	
90548-	275 x 70 mm	Polyester PBT 0.50	140		1	2	3	4	5	6	7	8	11	12

Hand scrub Brush

Waschbürsten | Skurebørste | Brosses à laver

95063-	210 x 70 mm	Polyester PBT 0.50	135		1	2	3	4	5	7	8	11	12
--------	-------------	--------------------	-----	--	---	---	---	---	---	---	---	----	----



Waterfeed



Waterfed Hygiene brushes are especially designed for professional use, where water-cleaning is a clear advantage or a necessity for best results. The range of Waterfeed articles are often used by professionals for avoiding potential abrasions to fine surfaces, and providing a superior finish.



What is Waterfed?

A special designed range of articles, where water comes out from each filament bundle. This provides a constant flow of water to the working area/spot. Our range of waterfed articles are: deck scrubs, handles, churn brushes, waterguns with couplers/hose and washing brushes.

Wasserdurchlauf

Bürsten mit Wasserdurchlauf wurden für alle professionellen Reinigungszwecke konzipiert, bei denen eine Nassreinigung deutliche Vorteile bringt oder optimale Reinigungsergebnisse gefordert sind. Produkte mit Wasserdurchlauf werden häufig von Profis genutzt, um mögliche Schäden an empfindlichen Oberflächen zu vermeiden und ein hervorragendes Reinigungsergebnis zu erzielen.

Vandgennemløb

Hygiene børster med vandgennemløb er specielt designet til professionelt brug, hvor vandtilførsel er en klar fordel eller en nødvendighed for det bedste resultat. Vandgennemløbssortimentet bruges ofte til afvaskning eller til rengøring på fine og følsomme overflader, og giver et overlegent resultat.

Ecoulement de l'eau

Ce système de nettoyage par écoulement de l'eau est tout particulièrement orienté pour un usage professionnel, dans les cas où un lavage à l'eau représente un avantage certain ou une nécessité pour de meilleurs résultats. La gamme d'articles permettant l'écoulement de l'eau sont le plus souvent utilisés par des professionnels afin d'éviter une détérioration éventuelle des surfaces fines, et permet une finition supérieure.

Deck scrubs

Schrubber | Gulvskrubber | Lave pont

24153-	300 x 60 mm	Polyester PBT 0.50	‡25		1	2	3	4	5
29154-	285 x 120 mm	Polyester PBT 0.50	‡25/40		1	2	3	4	5



24153



29154

Washing brushes with rubber edge

Waschbürsten mit Gummikante | Vaskebørster med gummikant | Brosses à laver avec bord caoutchouc

22104-	200 x 80 mm	Polyester PBT 0.30	‡55			2			
24104-	265 x 90 mm	Polyester PBT 0.30	‡55		1	2	3	4	5
24144-	265 x 90 mm	Polyester PBT 0.30	‡55		1	2	3	4	5



24104

22104



24144



Waterfeed

Water comes out from each filament bundle.
Wasser tritt aus und umspült dabei jedes einzelne Borstenbündel.
Vandet kommer ud af hver filamentsamling = hele børstefladen.
L'eau s'écoule entre chaque touffe de fibres.



Rubber edges

Colour coded rubber edges bonded to brush body to protect delicate surfaces from damage whilst water brushing.
Die Gummikante ist in der Farbe des Bürstenkörpers gehalten. Sie schützt empfindliche Oberflächen vor Beschädigungen während der Nassreinigung.
Blød farvekodet gummikant modvirker skader på følsomme overflader.
Bords caoutchoucs avec code couleur liés au corps de la brosse pour protéger les surfaces délicates d'une détérioration lors de l'utilisation.

Washing brushes

Waschbürsten | Vaskebørster | Brosses à laver

24106-	300 x 60 mm	Polyester PBT 0.30	‡55		1	2	3
29105-	290 x 130 mm	Polyester PBT 0.30	‡40		1	2	3



Washing brushes WITHOUT WATERFEED

Waschbürsten ohne Wasserdurchlauf | Vaskebørster uden vandgennemløb | brosses à laver sans écoulement d'eau

22105-	225 x 60 mm	Polyester PBT 0.30	‡55		1	2	3	4	5
22155-	225 x 60 mm	Polyester PBT 0.50	‡55		1	2	3		

Washing brush w/side filaments, WITHOUT WATERFEED

Waschbürste halbrund ohne Wasserdurchlauf | Vaskebørster med sidebørster uden vandgennemløb
Brosses à laver avec fibres doubles combinées sans écoulement d'eau

20105-	290 x 130 mm	Polyester PBT 0.30	‡40		1	2	3	4	5
--------	--------------	--------------------	-----	--	---	---	---	---	---



Ergonomic handles

Aluminiumstiele, ergonomische Form | Skafter, ergonomisk | Manches ergonomiques

29824-	1500 x 32 mm	½" nippel ½" Anschluß ½" nippel ½" Cople		1	2 3 4 5
29825-	1750 x 32 mm	½" nippel ½" Anschluß ½" nippel ½" Cople		1	2 3 4 5

Ergonomic telescopic handles

Ergonomische Teleskopstiele | teleskopskafter, ergonomisk | Manche ergonomique telescopique

29828	1280 → 2000 x 32 mm	½" nippel ½" Anschluß ½" nippel ½" Cople		1	2 3 4 5
29826-	1720 → 2820 x 32 mm	½" nippel ½" Anschluß ½" nippel ½" Cople		1	2 3 4 5



Churn brushes with rubber handgrip/edge - 1/2" nippel

Stielbürsten mit rutschfestem Griff - ½" Anschluß | Spandebørster m/gummikant - ½" nippel
Brosse avec manche bi matière - 1/2 cople

52144-	300 x 75 mm	PBT 0.30	½" nippel ½" Anschluß ½" nippel ½" Cople	‡35		1	2 3
52154-	300 x 75 mm	PBT 0.50	½" nippel ½" Anschluß ½" nippel ½" Cople	‡35		1	2 3 4 5

Churn brushes with rubber handgrip/edge - Euro nippel

Stielbürsten mit rutschfestem Griff - Euro Anschluß | Spandebørster m/gummikant - Euronippel
Brosse avec manche bi matière - cople europeoe

51104-	300 x 75 mm	PBT 0.30	Euro nippel Euro Anschluß Euro nippel Cople europeoe	‡45		2
51154-	300 x 75 mm	PBT 0.50	Euro nippel Euro Anschluß Euro nippel Cople europeoe	‡35		2



Watergun, standard model with 1/2" nippel

Waschpistolen, 1/2" Anschluß | Spulepistoler, 1/2" nippel | Pistolets à eau,

0405 1/2" 8 bar - 95°C Standard | Standard | Standard | Standard



Waterguns, heavy duty model

Waschpistolen, Profiausführung | Spulepistoler, industri model
Pistolets à eau, modèle Gros Travaux

0410- 12 bar - 50°C Light weight model | Leichtes Modell | Letvægts model | Modèle léger



2

0411- 24 bar - 95°C Heavy duty model | Schweres Modell | Industri vandpistol | Modèle haute résistance
Brass | Messing | Messing | Laiton



1

2 3 4 5 6

0412- 25 bar - 95 C Small / brass | Klein / messing | Lille / messing | Peu / laiton



2

0413- 30 bar - 95 C Exclusive / brass | Eksklusiv / messing | Eksklusiv / messing | Exclusif / laiton



2

Nipple for heavy duty waterguns

Anschluss für Waschpistolen-Profiausführung | Nippel for industrivandpistoler
Embout pour pistolet à eau gros travaux

5370 1/2" - 3/4" Hose nipple with thread for guns | Anschlußstück mit Gewinde für Waschpistolen
Slange nippel for vandpistol | Embout avec pas de vis pour pistolet



5372 1/2" Nipple with thread for guns | Anschlußstück mit Gewinde für Waschpistolen
Koblings nippel for vandpistol | Embout pour pistolet



5373 3/4" Nipple with thread for guns | Anschlußstück mit Gewinde für Waschpistolen
Koblings nippel for vandpistol | Embout pour pistolet



Exclusive model:



0412

0413



0410

Watergun, heavy duty model with NYLON-body. For 12 bar and 50 C°. Light weight model.
Waschpistole, Profiausführung mit Polyamid-Innenleben, für max. 12 bar und 50°C. Leichteres Modell.
Industrivandpistol med NYLON-krop. Tåler 12 bar og 50 C°. Letvægtsmodell.
Pistolet à eau, modèle gros travaux en NYLON. Résistance: 12 bar et 50°C.



0411

Watergun, heavy duty model with brass-body. For 24 bar and 95 C°.
Waschpistole, Profiausführung mit Messing-Innenleben, für max. 24 bar und 95°C.
Industrivandpistol med messing-krop. Tåler 24 bar og 95 C°.
Pistolet à eau, modèle gros travaux en LAITON. Résistance: 24 bar et 95°C.

Couplers 1/2"

Kupplungen 1/2" | Koblinger 1/2" | Embout 1/2"

5350	1/2"	Hose coupler Schlauchkupplung Slangekobling Embout pour tuyau	
5353	1/2"	Hose coupler with waterstop Schlauchkupplung mit Wasserstop Kobling med vandstop Embout pour tuyau avec arrêt	
5355	1/2"	Hose coupler with swivel + waterstop Schlauchkupplung mit 45° Winkel und Wasserstop Kobling med vandstop og vinkel Embout coudé pour tuyau avec arrêt	
5365	1/2"	Connector Verbindungsstück Koblingsled Connecteur	

Couplers 3/4"

Kupplungen 3/4" | Koblinger 3/4" | Embout 3/4"

5351	3/4"	Hose coupler Schlauchkupplung Slangekobling Embout pour tuyau	
------	------	---------------------------------------------------------------------	--

Tap coupling

Wasserhahn - Anschlussstück | Nippel til vandhane | Embout

5361	1/2"-3/4"-M22x1		
------	-----------------	--	--

Hose

Wasserschlauch | Slange | Tuyau

045050	1/2", 50 m, 13 bar	PVC PVC PVC PVC	
--------	--------------------	-----------------------	--

045050



Information

for Waterguns, heavy duty model



Flow chart

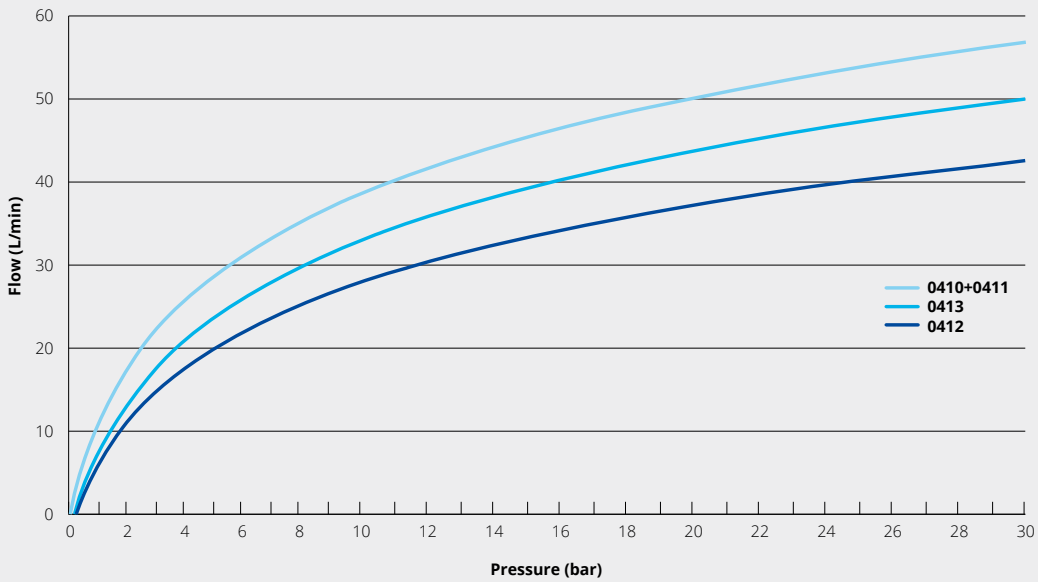

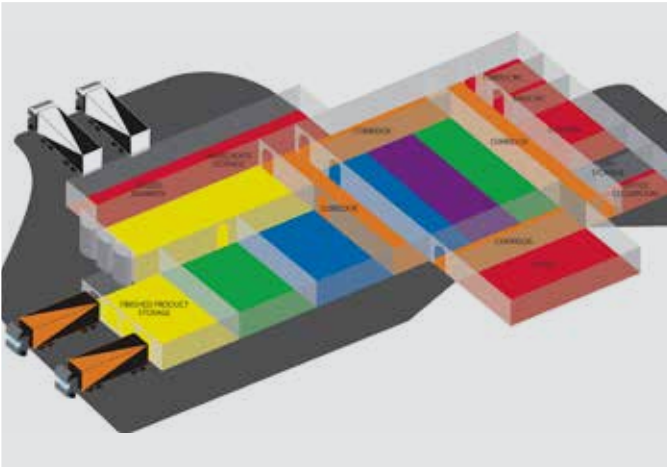

General information

Chemical	Concentration %	Polyester PBT	Polypropylene	Nylon 66
Acetic acid	100	*	***	*
Acetone	100	***	***	***
Ammonia Liquid		**	***	***
Aniline	100	***	**	*
Benzene	100	***	*	***
Bleaching Solutions Dilute		***	***	*
Caustic Potash	10	***	***	***
Caustic Potash	50	**	***	***
Chlorine Water Saturated		*	*	*
Chloroform	100	***	**	*
Chromic Acid	10	***	***	**
Citric Acid	10	***	***	**
Detergent-soaps		***	***	***
Ethanol	96	***	***	***
Ethyl acetate	100	***	***	***
Formic Acid	100	***	**	*
Fuel oil		***	**	***
Glycerine		***	***	***
Hydrochloric acid	30	**	***	*
Lactic Acid	20	***	***	**
Methyl Alcohol	100	***	***	***
Mineral oil		***	***	***
Nitric Acid	10	***	***	*
Nitric Acid	50	***	*	*
Oleic acid	100	***	***	***
Oxalic Acid	10	***	**	*
Petrol		***	**	***
Phosphoric Acid	85	***	***	*
Sea Water	100	***	***	***
Sodium Chloride (salt)		***	***	***
Sodium Hydroxide	10	*	***	***
Sodium Hydroxide	50	*	***	***
Sodium Hypochlorite	10	***	***	*
Stearic Acid	100	***	***	**
Sulphuric Acid	10	***	***	*
Sulphuric Acid	96	*	*	*
Tetrachloroethylene		**	*	**
Toluene	100	**	*	***
Trichloroethylene		**	**	***
Turpentine	100	***	*	***
Vaseline		***	***	***
Vegetable Oil		***	***	***

Generally:
PBT - pH 1-7 resistant to acids
PP - pH 1-14 resistant to both acids and alkalines
Depending on concentration and time in contact.

Allgemein:
PBT - resistent gegenüber Säuren mit PH-Wert 1 - 7
PP - resistent gegenüber Säuren und alkalischen Lösungen abhängig von der Konzentration und der Dauer des Kontaktes.

Generelt:
PBT - pH 1-7 resistent over for syrer
PP - pH 1-7 resistent over for både syre og baser
Afhængig af koncentration og tiden med kontakt.

Généralement:
PBT - pH 1 à 7; résiste aux acides
PP - pH 1 à 7; résiste aux acides et solutions alcalines
Dépend de la concentration et de la durée du contact.

- ←.....
- *** = Excellent; no deterioration or long-term adverse effects. 😊
 - ** = Caution; variations in concentration, temperature and exposure could be detrimental. 😊
 - * = Unsatisfactory; contact will result in permanent deterioration. 😞

Notes:

The information provided assumes temperatures not exceeding 20° Celsius. Concentration % relates to % chemical substance in total mix with water. Information is based on data provided by suppliers of our raw materials, who state: "we believe it to be true and accurate, but no warranties are expressed or implied regarding its accuracy or the performance of any product. Testing is recommended for critical applications".

- *** = besonders geeignet; keine Verschlechterung oder langfristige nachteilige Auswirkungen. 😊
- ** = bedingt geeignet - Achtung; Änderungen in der Konzentration, Temperatur oder Kontaktdauer können Beschädigungen verursachen. 😊
- * = unzureichend geeignet; Kontakt führt zu permanenter Verschlechterung der Bürsteneigenschaften. 😞

Hinweise:

Die zur Verfügung gestellten Informationen gehen von der Annahme aus, dass Temperaturen von 20° Celsius nicht überschritten werden. Die Konzentration % bezieht sich auf die chemische Substanz komplett in Wasser gelöst. Alle Informationen beruhen auf Daten unserer Roh-stoff-Lieferanten, die uns gegenüber erklären: "Wir gehen davon aus, dass alle Angaben der Wahrheit und Richtigkeit entsprechen, geben jedoch keine explizite oder implizite Garantie zur Richtigkeit in Bezug auf die Leistungsmerkmale eines Produkts ab." Daher empfehlen wir für kritische Anwendungen unbedingt Vorabtests.

- *** = Fremragende; ingen forringelse eller længerevarende bivirkninger. 😊
- ** = Forsigtig; variationer i koncentrationen, temperatur og udsættelse kan være skadelig. 😊
- * = Utilfredsstillende; kontakt vil resultere i permanent forringelse. 😞

Note:

Oplysningerne forudsætter at temperaturer ikke overstiger 20°C. Koncentration i % er baseret på % kemisk substans blandet med vand. Oplysningerne er baseret på data fra råvare leverandøren, der angiver: "Vi mener at oplyste informationer er sande og korrekte, men vi kan ikke stille garantier, hvilket er et udtryk for informationens nøjagtighed ved brugen af det enkelte produkt". Det anbefales at teste produktet ved kritiske anvendelse.

- *** = Excellent: pas de détérioration ou d'effets négatifs à long terme. 😊
- ** = A traiter avec prudence: des variations de concentration, température ou d'exposition peuvent nuire à la qualité du produit. 😊
- * = Insatisfaisant: tout contact résulte en une détérioration permanente. 😞

Notes:

L'information fournie est valable pour une température n'excédant pas 20°C. Le "pourcentage de concentration" fait référence à la quantité de substance chimique totale combinée à l'eau. Les précédentes informations sont basées sur les données de nos fournisseurs de matière 1ère, qui déclarent: "nous la considérons comme vraie et précise, mais aucune garantie n'est donnée ou impliquée quant à sa précision ou à la performance de tout produit en découlant". Des tests sont recommandés pour tout usage intensif.

General information

Colour coding

Always attentive to the requirements of valued customers, we now offer up to 11 colours: white, blue, red, yellow, green, orange, purple, pink, black, grey and brown.

Tolerance data

In consideration for the requirements of the industry, articles are available with heat tolerances from -30°C/-22°F to +134°C/+273°F (even some up till +250°C/+480°F).

Extrusions for all brush bodies, shovels, buckets etc.

FBK manufactures from colour coded virgin polypropylene injected under very high pressure to produce solid, strong mouldings. This production technique sets FBK products apart from foamed injection methods.

Brush filaments

The majority of brushware is filled using polyester PBT filaments of various lengths and thicknesses to suit the application. This material is extremely suitable for autoclaving to +120°C/+248°F, does not absorb water, and is therefore ideal in retaining bristle stiffness and bend recovery. It wears longer and withstands destruction from a wide range of caustic cleaning chemicals. Filament retention is important to FBK and the combination of precision drilled high density brush blocks and insertion of stainless steel retaining clips achieves this objective whilst allowing for the penetration of anti-bacterial agents to reach deep into the bristle clumps.

Ergonomics

FBK aims to develop articles that are not only fit for purpose but are also ergonomic and user-friendly. Our design team will always consider what achieves the best results with the least fatigue.

Where our products perform

Anywhere and everywhere that uncompromising cleanliness is the overarching requirement. Typical market types that appreciate our products include: food and beverage processing, food handlers, service sector and retail outlets, pharmaceutical and medical manufacturers, hospitals, municipal cleaning, contract cleaners etc.

Compliance

FBK articles conform to the best principles of HACCP, are manufactured from FDA compliant materials and are made in accordance with EU regulations 10/2011/EC; 1935/2004/EC; 2023/2006; 579/2011/EC; EU directive 93/43/EEC; 2002/72/EC; FDA food code 2009. As an active member of the European Brushware Federation, the company works in accordance with the PHB charter issued by FEIBP.

Declaration of compliance/Migration test

For articles which are meant for direct food contact, migration tests have been made according to EU regulation 10/2011/EC

Conformity

With the above accreditations and conformance guarantees, FBK articles qualify to fit into HACCP, the International Features Standard (IFS), the BRC Global standards and the 5S concept for L.E.A.N. management.

Allgemeine Informationen

Farbcodierung

Durch ständige Marktbeobachtung wird auf Kundenwünsche reagiert, so dass nun bis zu 11 Farben: weiss, blau, rot, gelb, grün, orange, violett, pink, schwarz, grau und braun, produziert werden.

Toleranz Daten

Um die Anforderungen der Industrie zu erfüllen, haben die Produkte folgende Toleranzen von -30°C/-22°F bis +134°C/+273°F (einige sogar von +250°C/+480°F).

Profile für alle Bürsten – und Besenkörper, Schaufeln, Eimer etc.

FBK fertigt aus hochwertigem Polypropylen geschlossporige Körper. Hierdurch entstehen keine Luftfeinschlüsse wie beim Schäumverfahren. Deshalb hat man eine feste Verbindung zwischen Körper und Borsten. Die glatte und schmutzabweisende Oberfläche der Körper, ohne unnötige Winkel und Ecken bewirken, dass sich keine Mikroorganismen festsetzen können.

Filamente/Besatzmaterial

Die meisten Hygiene-Artikel sind mit Polyester PBT Borsten bestückt. Dies gibt es in verschiedenen Stärken und Längen, um den Anwendungen zu entsprechen. Das Material ist sterilisierbar und autoklavierbar (bis +120°C/+248°F). Polyester PBT Borsten nehmen keine Feuchtigkeit auf und behalten ihre ursprüngliche Festigkeit. Dadurch hat dieses Besatzmaterial eine hohe Abriebfestigkeit und eine lange Lebensdauer. Diese Filamente widerstehen sehr vielen ätzenden Reinigungsmitteln. FBK nutzt eine Vorratdatenspeicherung. Diese ist wichtig, um leichter auf Kundennachfragen reagieren zu können. Die Borstenbündel werden mit Edelstahlklammern in die hochwertigen Kunststoffkörper eingestanz. Durch diese Verbindung wird das Eindringen anti-bakterieller Erreger fast unmöglich gemacht.

Ergonomie

Die Designer von FBK entwickeln nicht nur Produkte die ihren Zweck erfüllen, sondern sie sollen vor allem ergonomisch und benutzerfreundlich sein. Dadurch werden gute Arbeitsergebnisse mit wenig Ermüdungserscheinungen für den Anwender erzielt.

Wo unsere Produkte sich abheben

Typische Bereiche die mit unseren Produkten arbeiten sind: Nahrungs- und Getränkeindustrie, Lebensmittelindustrie, Pharma – und Medizintechnik, Dienstleistungsunternehmen, Krankenhäuser, Gebäudereiniger, Einzelhandel, Stadtreinigungen etc. Die beste Sauberkeit zu erreichen ist für FBK oberste Priorität.

Beachtung

FBK Artikel entsprechen den Vorschriften HACCP, und sind aus konformen Materialien gefertigt, die von FDA gefordert werden und beinhalten die EU-Vorschriften 10/2011/EC; 1935/2004/EC; 2023/2006; 579/2011/EC; EU directive 93/43/EEC; 2002/72/EC; FDA food code 2009. Als aktives Mitglied der European Brushware Federation arbeitet FBK an der Einhaltung und Gestaltung der PHB-Charter. Das Sortiment ist von FEIBH registriert. Diese Vorschriften sind speziell für die Hersteller von Hygiene Bürsten entwickelt worden.

Migrationstest

Für unsere Artikel, die mit Lebensmitteln in Berührung kommen, haben wir die Migration Prüfungen gemäß EU Regulation 10/2011/EC durchgeführt.

Konformität

Mit den vor genannten Übereinstimmungen und Konformitätserklärungen entsprechen FBK Produkte der HACCP, the International Features Standard (IFS) the BRC Global standards and the 5S concept for L.E.A.N. management.

Generel information

Farvekodning

Med vores kunders behov i fokus, tilbyder vi nu et sortiment med op til 11 farver: Hvid, blå, rød, gul, grøn, sort, orange, lilla, pink, grå og brun.

Temperatur tolerance

I henhold til kravene inden for hygiejne industrien, opfylder vores produkter en temperatur tolerance fra -30°C/-22°F til +134°C/+273°F (nogle tåler temperatur helt op til +250°C/+480°F).

Generelt for alle børster, skovle, spande mm.

Børstekroppene produceres i fuldstøbt jomfrueligt polypropylene, der sprøjtestøbes i rustfri stålforme under meget højt tryk, hvilket resulterer i en fuldstøbt kompakt børstekrop med en glat smudsafvisende overflade. Produktionsteknikken adskiller sig fra den traditionelle produktionsmetode hvor børstekroppe støbes i aluminiums forme under mindre tryk, som resulterer i opskummet børstekroppe som er fyldt med indvendige lufthuller og ru overflade.

Børste filamenter

I langt hovedparten af vores produkter, bruges Polyester PBT filamenter af forskellige længder og tykkelser. Polyester PBT er varmebestandigt til +120°C/+248°F, tåler autoklavering, absorberer ikke vand og har derfor samme stivhed i våd som tør tilstand, desuden har den en rigtig god genopretningsevne. Filamenterne holder længere end traditionelle filamenter, og tåler en meget bred vifte af rengøringskemikalier m.m. Kvaliteten af filamenterne er naturligvis vigtig for os, og i kombinationen af præcis boring, nøjagtig isætning af filamenterne som fastholdes af rustfri stål kremper, resulterer det i en ekstrem holdbarhed og modvirker at filamenterne falder ud af børstekroppen.

Ergonomi

Produkterne bliver fremstillet brugervenligt og ergonomisk korrekt, derudover har vi et meget bredt sortiment af produkter, som sikrer et altid passende ergonomisk produkt til det givende formål, dermed et hurtigere og bedre resultat.

Hvor kan man bruge vores produkter?

Sortimentet er specielt designet til områder hvor der kræves en høj og effektiv kvalitet af rengøringen og hvor hygiejnen er essentiel, f.eks.: levnedsmiddel-, farmaceut industrien, bryggeribranchen, hospitaler, landbrug, supermarkeder, fødevarerforhandler og lign.

Lovkrav, forordninger og regulativer

Produkterne opfylder EC/EU kravene* til produkter der bruges i forbindelse med fødevarereproduktion. Alle produkter er produceret af FDA-godkendte råvare på "state of the art" maskiner. *EU regulativer 10/2011/EC; 1935/2004/EC; 2023/2006; 1068/2009/EC samt EU direktiver 93/43/EEC; 2002/72/EC. US Food and Drug Administration (FDA) Food Code 2009 HACCP (Food grade materials). Derudover er vi aktiv medlem i European Brushware Federation (FEIBP), hvor vi opfylder hygiejne charter PHB.

Overensstemmelseserklæring/Migration test

For produkter som er fremstillet til direkte kontakt med fødevarer, er der foretaget en migration test i overensstemmelse med EU regulering 10/2011/EC.

Certificeringer

Udover internationale lovkrav findes der også mange branche certificeringer, som skal overholdes, og dertil kan brugen af vores produkter hjælpe med til at overholde disse, f.eks.: HACCP konceptet (Hazard Analysis Critical Control Points) IFS konceptet (International Featured Standard for private brand producers of foodstuffs) 5S konceptet (Sorting, Set in order, Shine/Sweep, Standardizing, Sustain the system) BRC Global standards.

Informations générales

Code Couleur

Toujours à l'écoute des desiderata de notre clientèle, nous proposons désormais une gamme de jusqu'à 11 couleurs : blanc, bleu, rouge, jaune, vert, orange, violet, rose, noir, gris et marron.

Domaine D'utilisation

Étant donné les exigences en usage industriel, nos produits sont disponibles pour utilisation à des températures allant de 20 °C à +134 °C (et pour certains même jusqu'à +250 °C).

Toutes Les Semelles De Nos Brosses, Nos Pelles, Nos Seaux, Etc., Sont Extrudés

À l'encontre des produits courants en plastique expansé, FBK utilise du polypropylène vierge de couleur injecté à très haute pression, ce qui permet la réalisation de pièces moulées massives et solides.

Fibres De Brosses

La plupart de nos articles de brosse sont réalisés en fibre de polyester PBT de différentes longueurs et sections en fonction de leur usage. Ce matériau convient parfaitement pour une fabrication en autoclave à +120°C/+248°F. Il n'absorbe pas l'eau, grâce à quoi les fibres restent raides, se redressant après déformation. Il résiste très bien à l'usage comme à de nombreux produits de nettoyage agressifs. FBK attache une grande importance à la solidité d'implantation des fibres, ce qui permet l'utilisation de corps en plastique à haute densité percés de trous avec une grande précision, trous dans lesquels les touffes sont fixées à l'aide d'agrafes en acier inoxydable. Ce système laisse aussi les agents désinfectants pénétrer en profondeur à l'intérieur des touffes. Suite à la demande de notre clientèle, nous proposerons bientôt des touffes fixées dans un composé en résine flexible, autorisant une solidité d'implantation accrue.

Detection Des Metaux

Pour les produits utilisés dans l'industrie alimentaire ou pharmaceutique, il peut être intéressant de pouvoir détecter les fragments s'étant détachés accidentellement d'un outil, ce au moyen des équipements de détection des métaux dont sont dotées les lignes de fabrication. Nous utilisons à cet effet des additifs de notre propre formulation, conformes à la réglementation en vigueur.

Ergonomie

FBK s'attache à concevoir des produits qui soient non seulement fonctionnels mais aussi ergonomiques et faciles à utiliser. Notre bureau d'étude cherche toujours à obtenir un nettoyage aussi efficace que possible avec le moins de fatigue possible.

Domaines D'utilisation

Partout où il s'agit d'abord de garantir la meilleure propreté. On retrouve nos produits dans l'agro-alimentaire, la production de boissons, la distribution des produits alimentaires, l'industrie pharmaceutique, la fabrication de produits médicaux, les hôpitaux, les municipalités, les sociétés de nettoyage, etc.

Conformite

FBK assure la fabrication de ses produits selon les principes de la méthode HACCP, avec des matières conformes aux exigences de la FDA et conformément à la réglementation européenne (règlements et directives 10/2011/CE, 1935/2004/CE, 2023/2006, 579/2011/CE, 93/43/CEE, 2002/72/CE) et américaine (FDA Food Code 2009). En tant que membre actif de la Fédération européenne de brosse et de pinceauterie, notre société se conforme également à la charte PHB sur la brosse professionnelle.

Test de migration

Les produits destinés au contact alimentaire subissent des essais de migration conformément au règlement 10/2010/CE en vigueur.

Conformite

Les produits de FBK répondent pleinement aux exigences de la méthode HACCP, au référentiel d'audit International Featured Standard (IFS), à la norme du BRC Global standards et aux principes des 5S du juste-à-temps.



11 Colours available

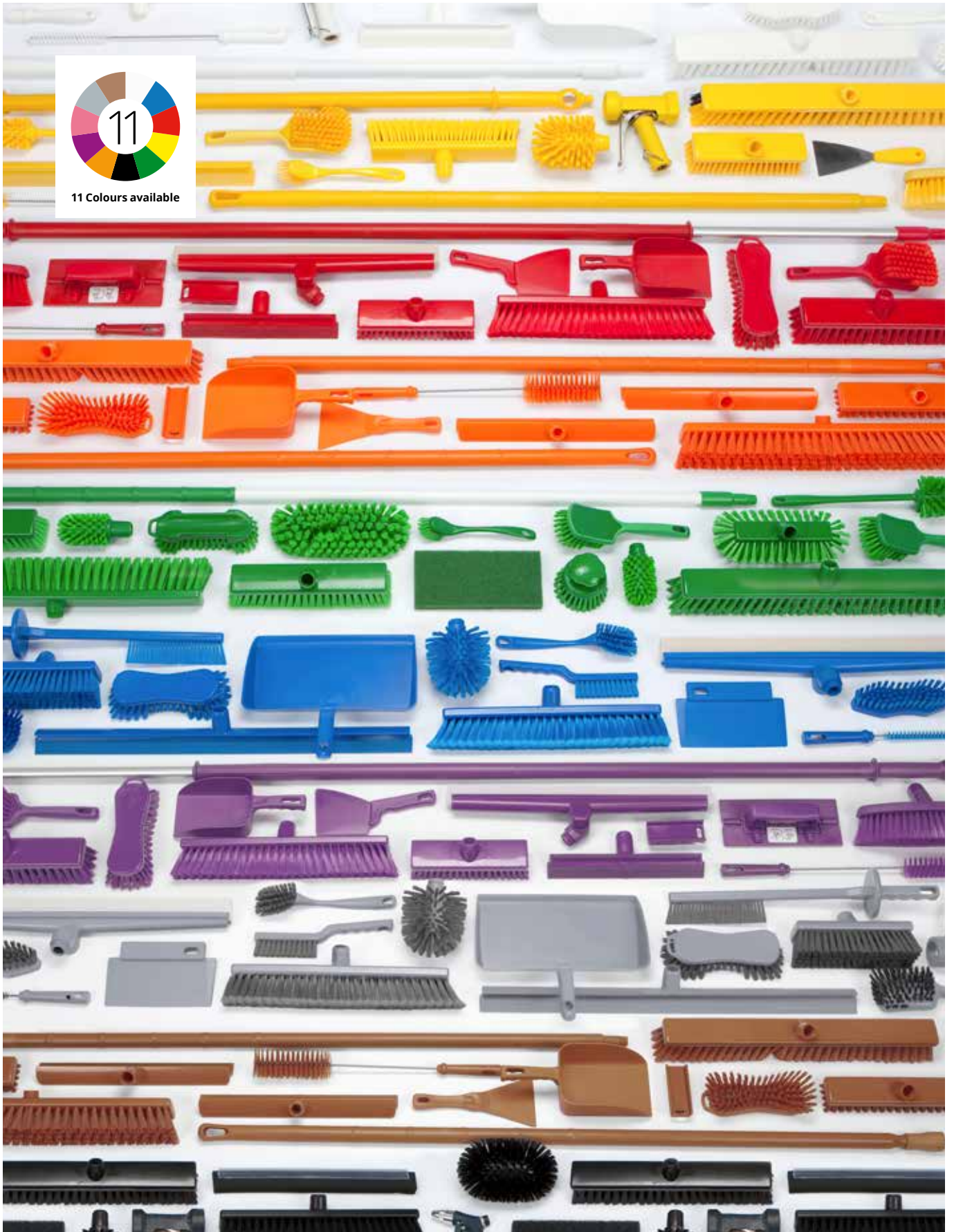

Contact us:

Fyens Børste- & Kostefabrik ApS
Teknikvej 53
DK-5260 Odense S
Denmark

+45 6614 3661

ks@fbk.dk

www.fbk.dk